



melogranoblu

SYSTEMS

LEGEND



CLEAR GLASS



FROSTED GLASS



RULED CLEAR GLASS



RULED FROSTED GLASS



METALLIZED RULED GLASS



METALLIZED



INNER LIGHT



REFLECTED LIGHT



SUSPENSION LAMP

INDEX

NOVA SYSTEM	
NOVA GLASSES	14
STROMBOLI & STROMBOLICCHIO	16
JANUS	20
BLEND A ORIZONTAL	22
BLEND A VERTICAL	26
GALENA	32
HYDRA SYSTEM	
COMPONENTS	56
HYDRA GLASSES	60
ACORN	62
ALPHA	64
ACQUA	66
AVATAR	68
BERRY	70
BERRY METAL	72
BETA	76
DATURA	78
DELTA	80
DERVISCI	82
DIESIS	84
GAMMA	86
LAMBDA	90
LHASA	92
OMEGA	94
ONION	98
ORGANIC	100
SIGMA	102

THE FACTORY OF EMOTIONS

CONCEIVED AND FOUNDED IN 1997 BY ERMANNOCCHI AND MASSIMO CREMA, MELOGRANOBLU IS AN ITALIAN INTERIOR LIGHTING COMPANY. OVER THE YEARS, THE COMPANY HAS DEVELOPED A WIDE RANGE OF SOLUTIONS FOR INTERIOR LIGHTING DESIGN, SUITABLE FOR HOMES OR OFFERING MORE IMPRESSIVE INSTALLATIONS FOR LARGE ARCHITECTURAL SETTINGS.

MELOGRANOBLU CREATIONS ARE VERITABLE SPECTACLES OF LIGHT, FOCUSING ON THE SENSORY AND EMOTIONAL EFFECT OF LIGHT THROUGH GLASS.

DESIGN PROJECTS IN WHICH ALL FORMS OF GLASS ARE CONCEIVED AND DESIGNED ACCORDING TO THE EFFECTS THEY CAN GENERATE THROUGH LIGHT.

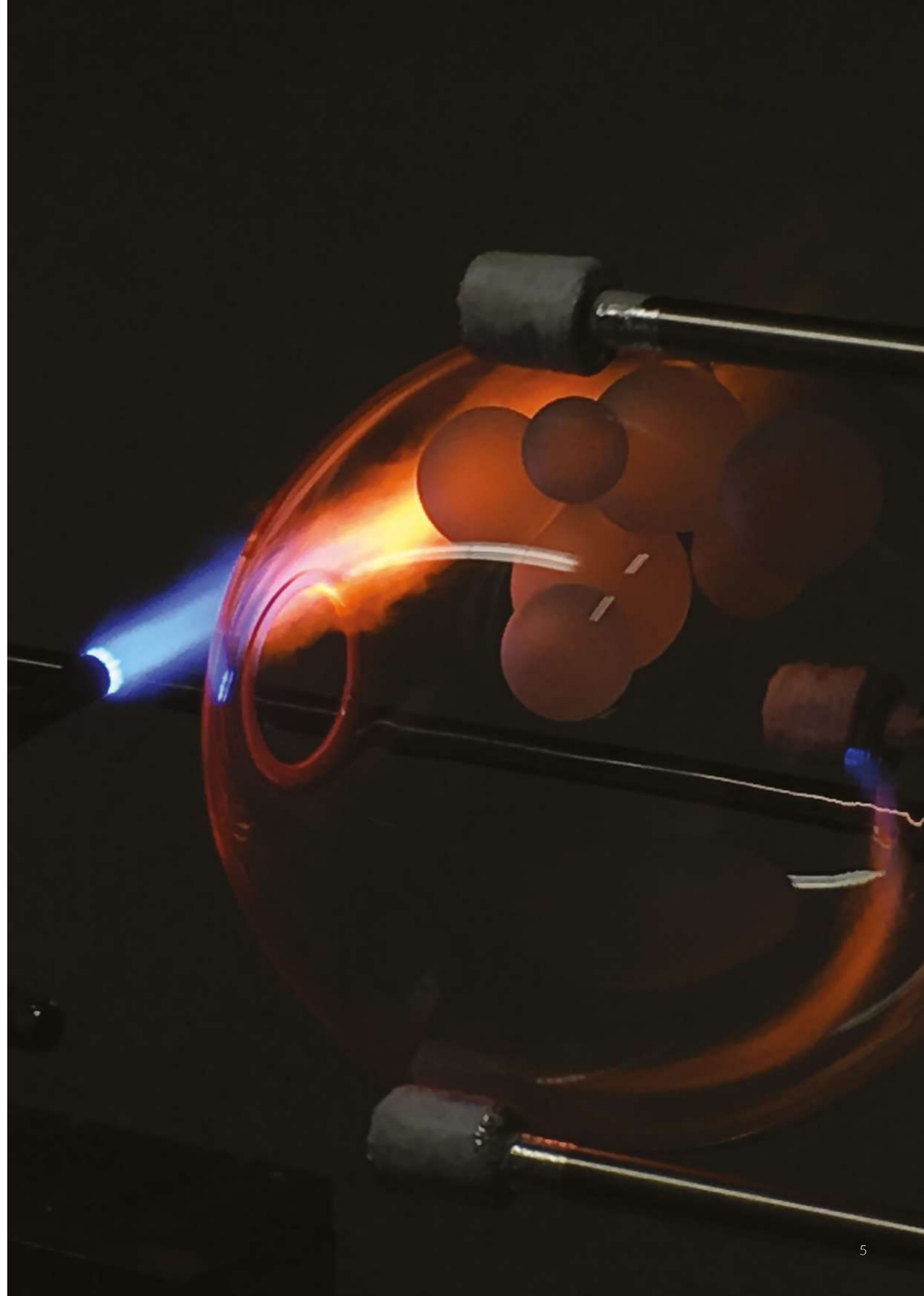

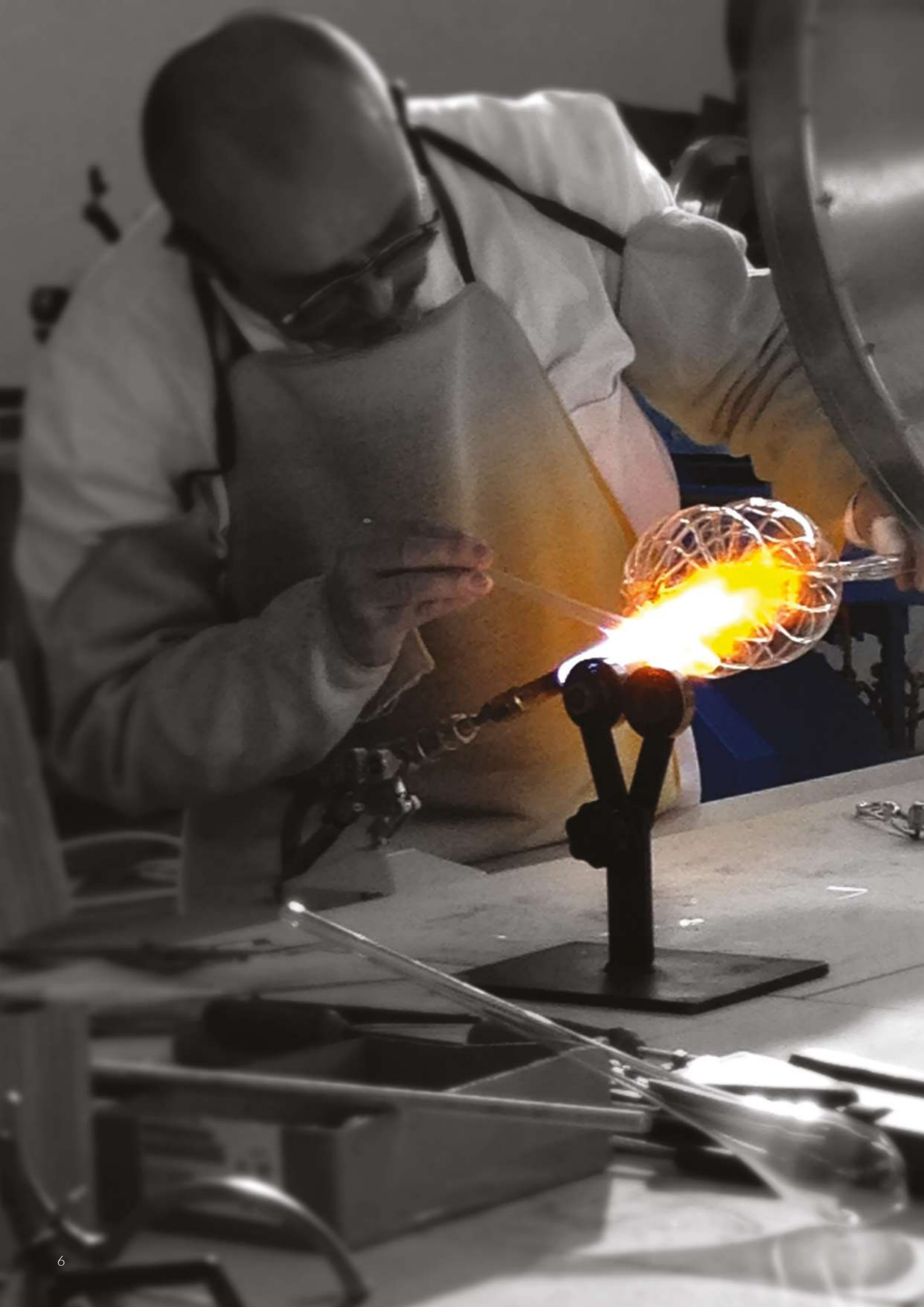

CRAFTED PRODUCTION AND INDUSTRIAL ORGANISATION

ALL MELOGRANOBLU DESIGNS ARE CONCEIVED, DEVELOPED, ENGINEERED AND PRODUCED IN THE COMPANY. A STRUCTURE ORGANISED TO MANAGE AND GUARANTEE "MADE IN ITALY" QUALITY THROUGHOUT THE ENTIRE PRODUCTION PROCESS.

UNIQUE PIECES, THE SAME YET DIFFERENT SINCE THEY ARE MADE WITH PASSION BY SKILLED HANDS THAT CREATE ARTWORKS FROM GLASS.

MADE-TO-ORDER

MELOGRANOBLU'S IN-HOUSE GROUP OF DESIGNERS WORKS IN COLLABORATION WITH THE CLIENT, DEVELOPING EACH SPECIFIC DESIGN IDEA TO ACHIEVE A MADE-TO-MEASURE LIGHT INSTALLATION.

MELOGRANOBLU MADE-TO-ORDER DESIGNS, ALL DEVELOPED AND ENGINEERED WITHIN THE COMPANY, ARE DELIVERED TO THE CLIENT COMPLETE WITH DETAILED INSTRUCTIONS TO GUIDE EASY INSTALLATION IN TOTAL SAFETY.



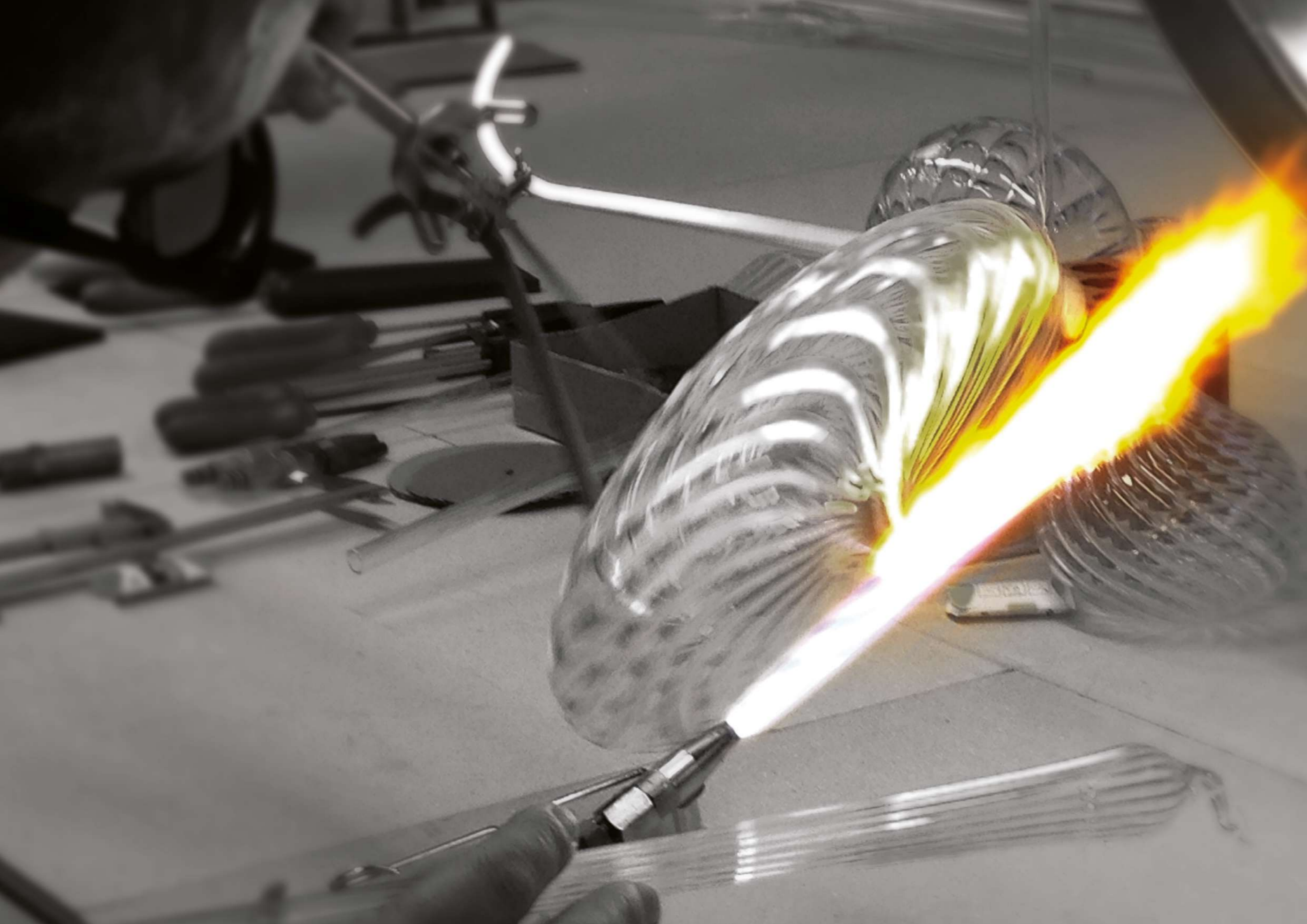



NOVA SYSTEM

NOVA PRESENTS AN EXCLUSIVE SELECTION OF BLOWN GLASS PENDANTS, EACH A MASTERPIECE OF DESIGN CONCEIVED TO EMBELLISH SPACES WITH STYLE AND SOPHISTICATION, EITHER INDIVIDUALLY OR IN SCENOGRAPHIC COMPOSITIONS.

EACH PENDANT IS EQUIPPED WITH AN INTEGRATED LIGHT SOURCE AND REPRESENTS EXCELLENT CRAFTSMANSHIP THAT GUARANTEES INCOMPARABLE QUALITY. NOVA CELEBRATES THE ART OF LIGHTING WITH TIMELESS ELEGANCE.

SIX DESIGNS ARE AVAILABLE: STROMBOLI AND STROMBOLICCHIO, JANUS, BLEND A HORIZONTAL, BLEND A VERTICAL, GALENA HORIZONTAL AND GALENA VERTICAL, EACH IN DIFFERENT SIZES AND FINISHES.



NOVA SYSTEM

GLASSES

1 STROMBOLI & STROMBOLICCHIO page 16

2 JANUS page 20

3 BLENDA ORIZONTAL page 22

4 BLENDA VERTICAL page 26

5 GALENA page 32

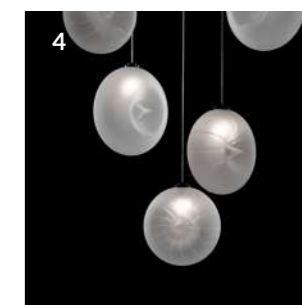

NOVA

STROMBOLI & STROMBOLICCHIO



HAND-BLOWN GLASS SHAPE CLEAR

Glass dimension:
Stromboli h. 15cm, ø 13 cm.
Strombolicchio h 10 cm., ø 15 cm.
Light source: G4 LED bulb 12 Volt, 2700k.
Metal parts in nickel finishing.
Electric coaxial cable 15 mt length maximum

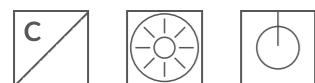



NOVA

JANUS



HAND-BLOWN RULED GLASS SHAPE

CLEAR, FROSTED OR METALLIZED FINISH AVAILABLE

Glass dimension: ø 16 cm.

Light source: G4 LED bulb 12 Volt, 2700k.

Metal parts in nickel finishing.

Electric coaxial cable 15 mt length maximum



NOVA

BLEND ORIZONTAL



HAND-BLOWN RULED GLASS SHAPE
CLEAR OR FROSTED FINISH AVAILABLE

Glass dimension:
Large h. 10cm, ø 21,5 cm.
Small h 9 cm., ø 18,5 cm.
Light source: G4 LED bulb 12 Volt, 2700k
Metal parts in nickel finishing
Electric coaxial cable 15 mt length maximum





NOVA

BLEND VERTICAL



HAND-BLOWN RULED GLASS SHAPE
CLEAR OR FROSTED FINISH AVAILABLE

Glass dimension:
Large h. 10cm, ø 21,5 cm.
Small h 9 cm., ø 18,5 cm.
Light source: G4 LED bulb 12 Volt, 2700k
Metal parts in nickel finishing
Electric coaxial cable 15 mt length maximum



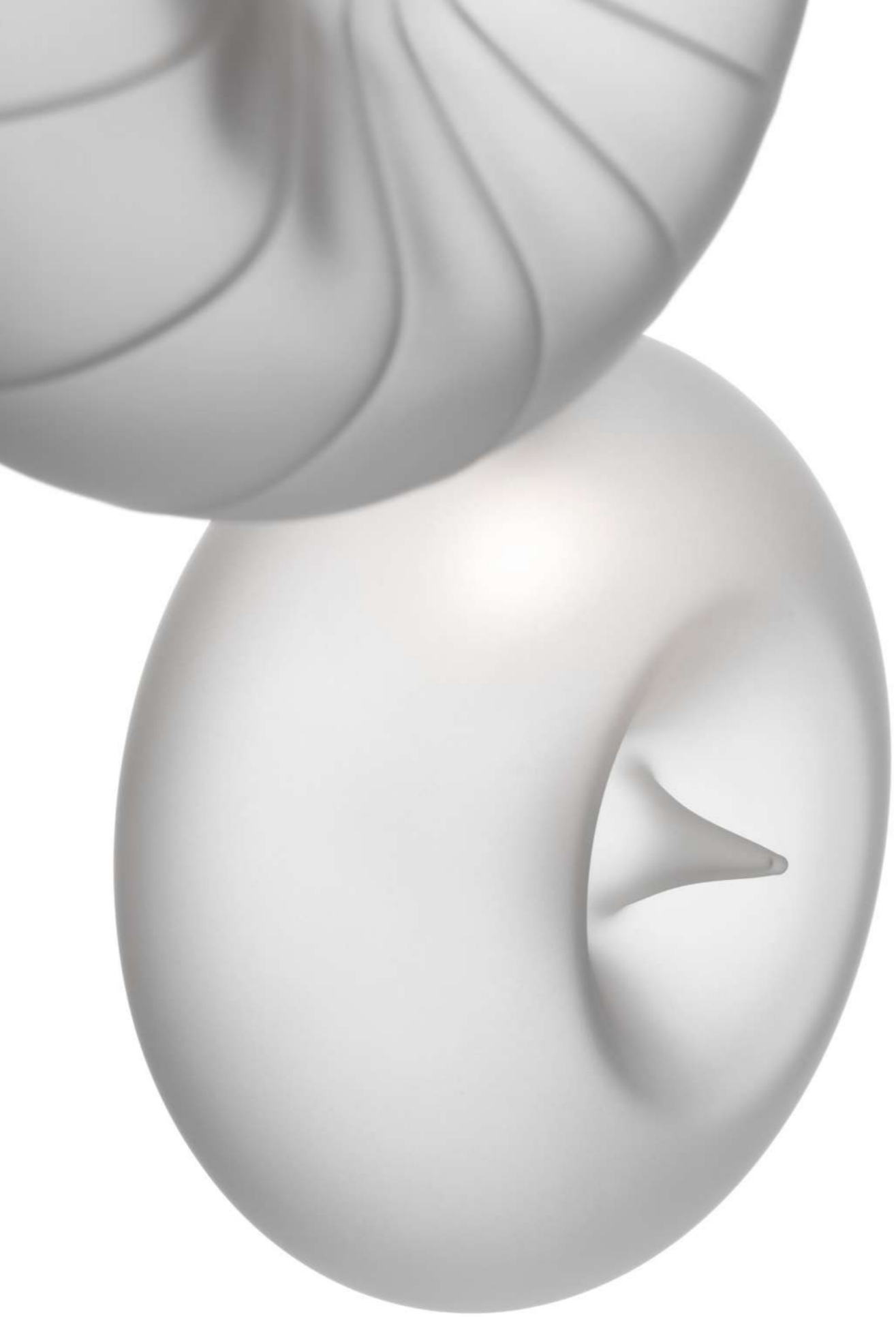

WHEN LIGHT MEETS
REFINED DESIGN.



NOVA

GALENA



HAND-BLOWN RULED GLASS SHAPE

CLEAR, FROSTED OR METALLIZED FINISH AVAILABLE

Glass dimension

Large l. 9 cm, ø 17 cm.

Small l. 8 cm., ø 14 cm.

Light source: G4 LED bulb 12 Volt, 2700k

Metal parts in nickel finishing







HYDRA SYSTEM

HYDRA IS A MODULAR LIGHTING SYSTEM FOR INTERIORS CREATED BY MELOGRANOBLU FOR DESIGNING AND CREATING ALLURING AND SOPHISTICATED LIGHTING COMPOSITIONS WITH GREAT EASE.

SHAPES IN BLOWN GLASS, CLEAR OR FROSTED, SUSPENDED USING COLOURED TUBULAR METAL LINKS, REFLECT THE LIGHT IN THE ROOM TO CREATE EVOCATIVE ATMOSPHERES.

VERSATILITY, LIGHTNESS, EASY INSTALLATION AND FREEDOM OF DESIGN ARE ITS DISTINCTIVE FEATURES.

WITH HYDRA YOU CAN CREATE COUNTLESS LIGHT CONFIGURATIONS SUITED TO ALL ARCHITECTURAL INTERIORS, BE THEY RESIDENTIAL OR CONTRACT.

THE IN-HOUSE GROUP OF DESIGNERS WORKS IN CLOSE SYNERGY WITH THE CLIENT IN CREATING SPECTACULAR COMPOSITIONS STUDIED FOR THE SPECIFIC INTERIOR DESIGN PROJECT. STARTING OUT WITH A CONCEPT, IT DEVELOPS A DETAILED SHOP DRAWING COMPLETE WITH INSTALLATION INSTRUCTIONS.



LIGHT CREATES
EVOCATIVE
ATMOSPHERES







VERSATILITY
AND FREEDOM
OF DESIGN







PRECIOUS
DETAILS.



TIMELESS
LIGHTING
SOLUTIONS





HYDRA SYSTEM

COMPONENTS

A LIGHT SOURCE
See page 34

B FIXING ACCESSORIES
See page 35

C METALLIC MESH ROPES
See page 35

D GLASSES
See page 36

A LIGHT SOURCE

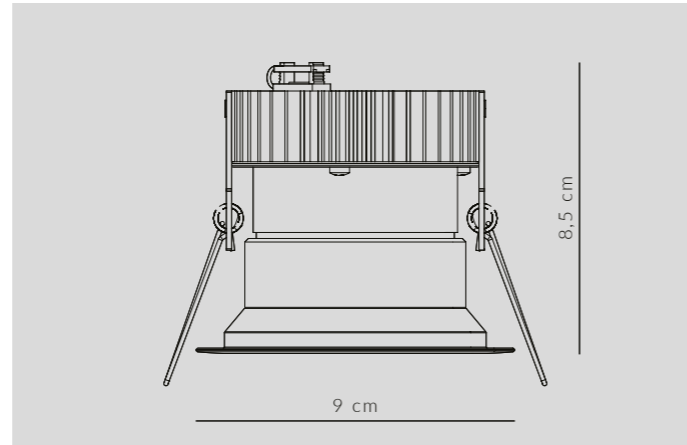

LED recessed projector 10W24Vdc 2700k cri93 optics 6° circular body ø 90 mm.

Hydra System is also customizable with: LED CEILING LIGHT (See page 80) or INNER LIGHTS.

INNER LIGHTS

METALLIC MESH ROPE CAN BE ELECTRIFIED, TO HAVE LIGHT INSIDE GLASSES.

- ① Special fixing support for false ceiling.
- ② Inner light for Hydra System glasses complete with special G4 pin LED bulb 2,5 W melogranoblu patent.

Additional inner light can be used only with following models: Alpha, Berry metal, Beta, Datura, Delta, Diesis, Gamma① .

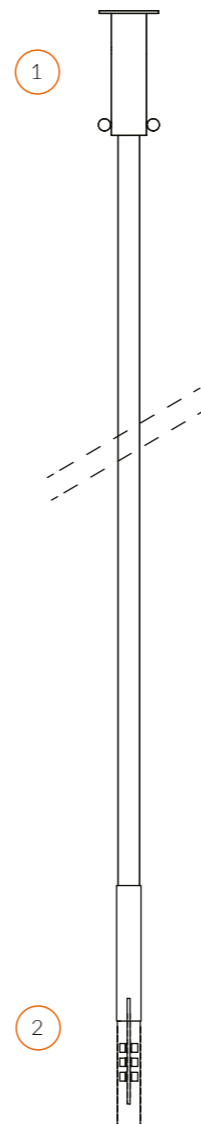

B FIXING ACCESSORIES



CEILING FIXING SUPPORT



FLOOR FIXING SUPPORT



GLASS FIXING METAL PIN

C METALLIC MESH ROPES

#T11 Red

#T34 Fuxia

#T39 Orange

#T26 Gold

#T36 Purple

#T35 Wistaria

#T12 China Blue

#T29 Turquoise

#T08 Titanium

#T00 Copper

#T20 Brown

#T07 Silver

#T21 Black



COLOURED METALLIC MESH ROPE TO HANG GLASSES.

Colors in this catalogue may lightly vary because of printing. melogranoblu reserve the right to modify products and colors, without notice, in order to make technical improvements.

D GLASSES

- 1 ACORN page 62
- 2 ALPHA page 64
- 3 ACQUA page 66
- 4 AVATAR page 68
- 5 BERRY page 70 | BERRY METAL page 72
- 6 BETA page 76
- 7 DATURA page 78
- 8 DELTA page 80
- 9 DERVISCI page 82
- 10 DIESIS page 84
- 11 GAMMA page 86
- 12 LAMBDA page 90
- 13 LHASA page 92
- 14 OMEGA page 94
- 15 ONION page 98
- 16 ORGANIC page 100
- 17 SIGMA page 102

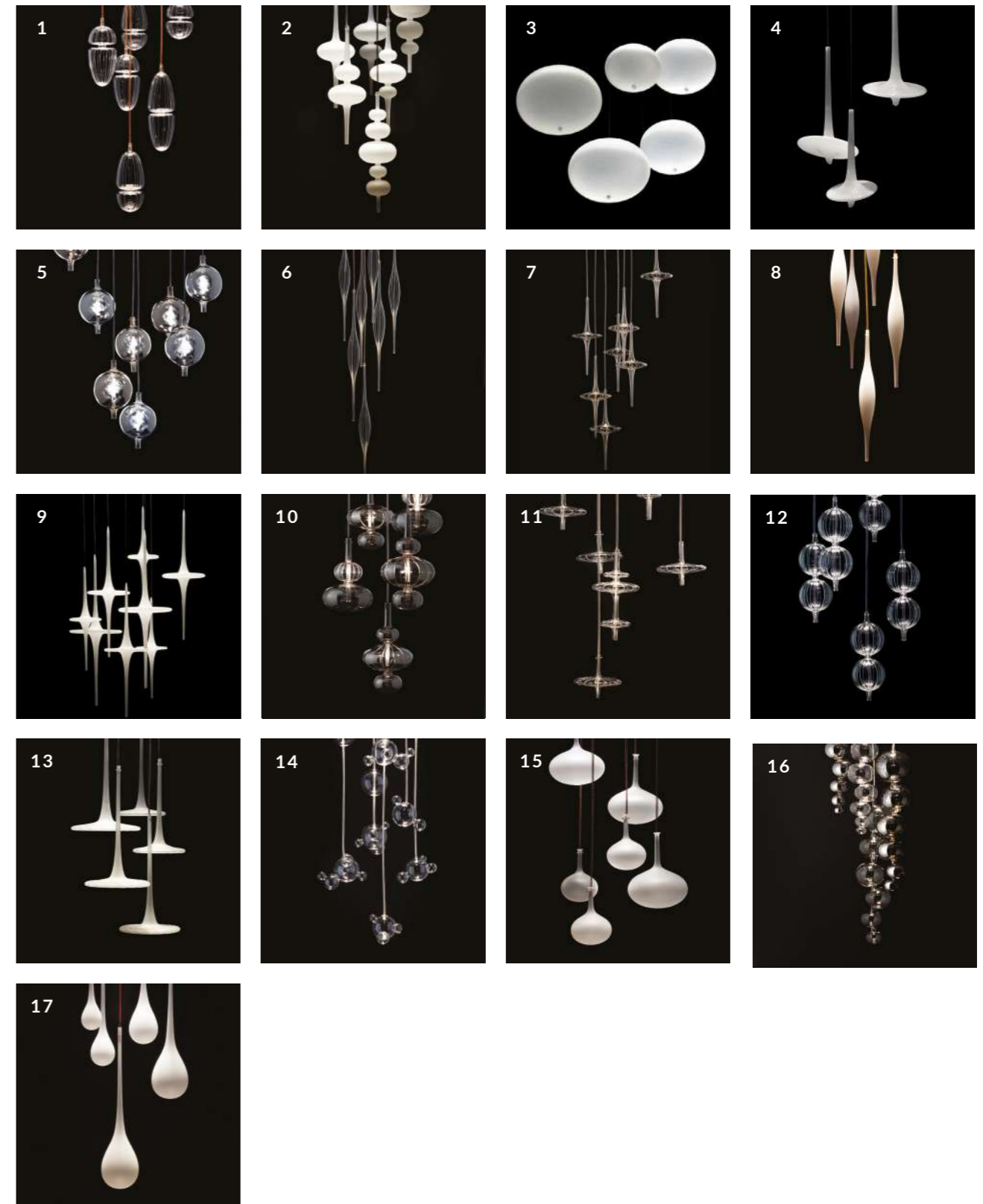

HYDRA

ACORN

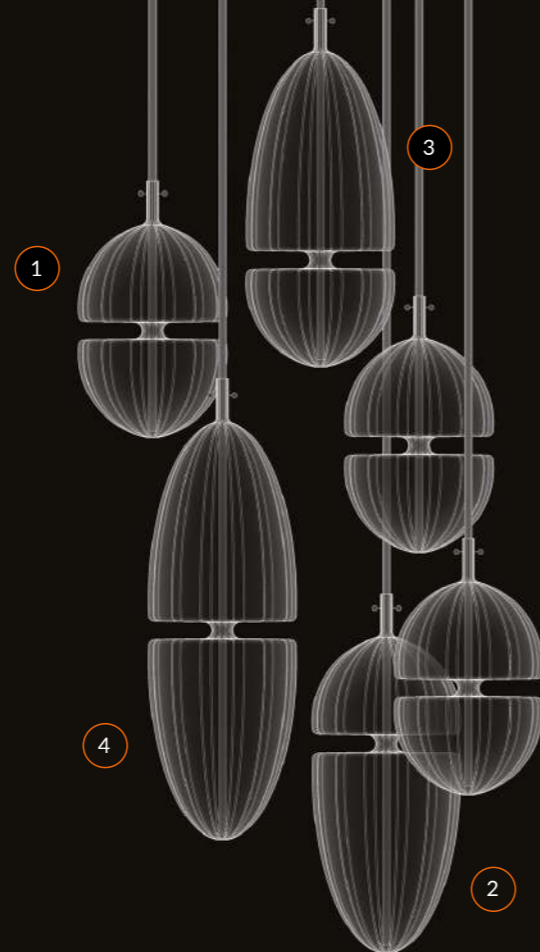

CLEAR OR FROSTED HAND-BLOWN RULED GLASS PENDANT.

4 shapes available: ① h. 21,5 - ø 12,5 cm. ② h. 30 - ø 12,5 cm. ③ h. 30 - ø 12,5 cm. ④ h 38,5 - ø 12,5 cm.



HYDRA

ALPHA

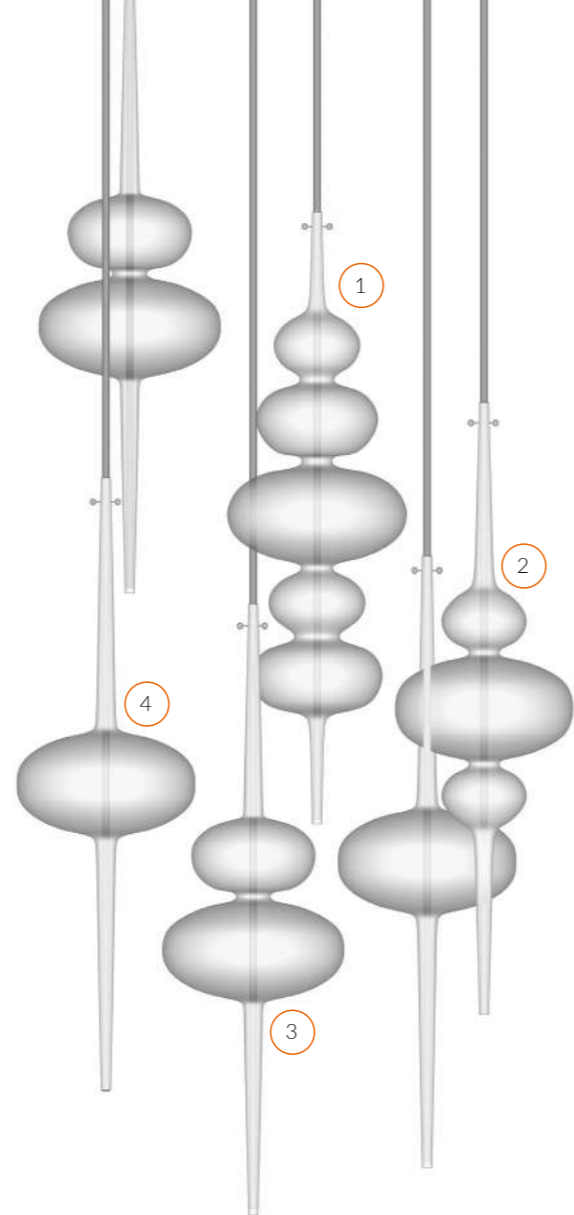

CLEAR OR FROSTED HAND-BLOWN GLASS PENDANT.

4 shapes available: ① h. 45 - ø 15,5 cm. ② h. 45 - ø 15,5 cm. ③ h. 45 - ø 15,5 cm. ④ h 45 - ø 15,5 cm.
Additional inner light can be used with this model (see page 34).



HYDRA

ACQUA

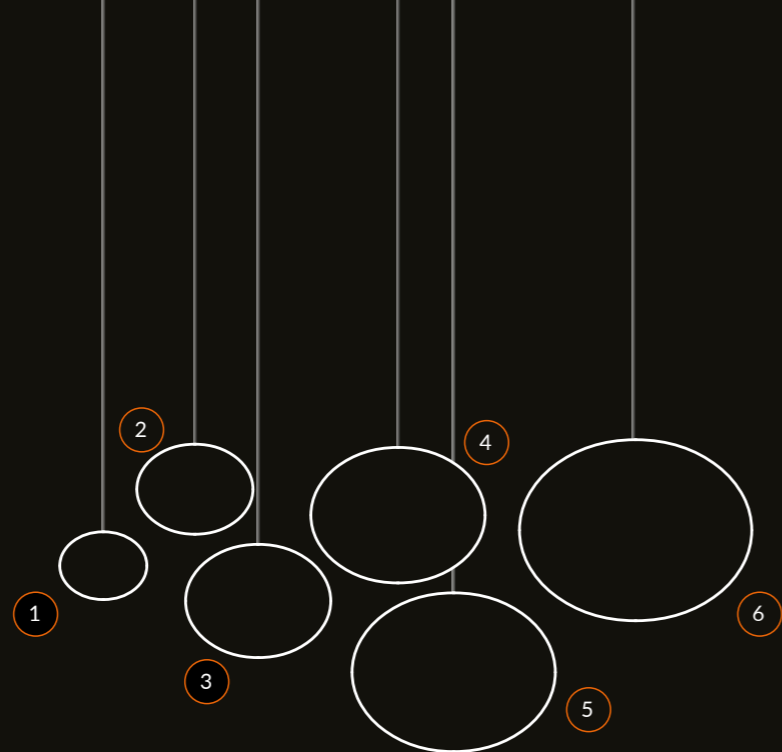

CLEAR OR FROSTED HAND-BLOWN GLASS PENDANT.

6 shapes available: ① ø 9 cm. ② ø 12 cm. ③ ø 15 cm. ④ ø 18 cm. ⑤ ø 21 cm. ⑥ ø 24 cm.

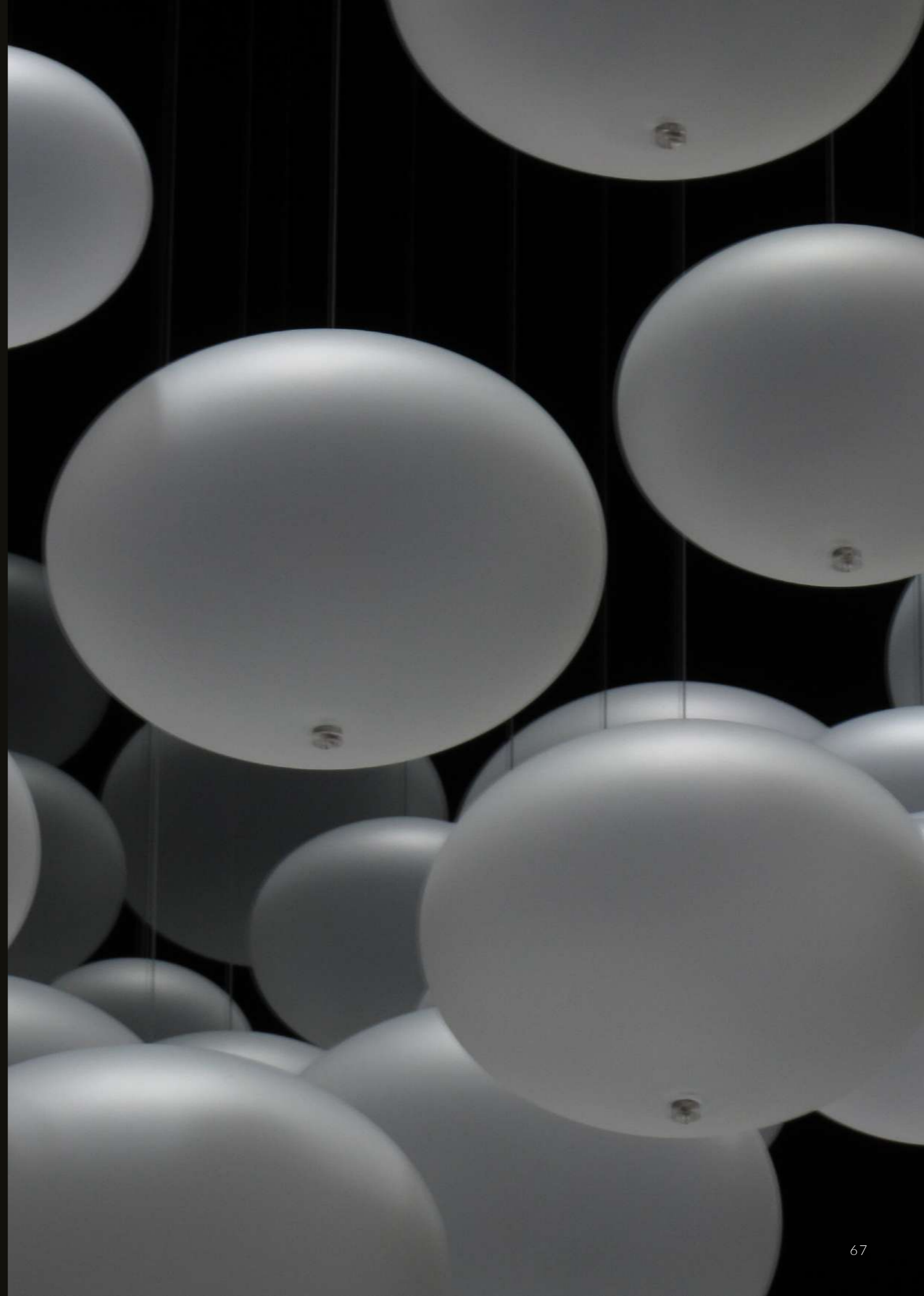

HYDRA

AVATAR

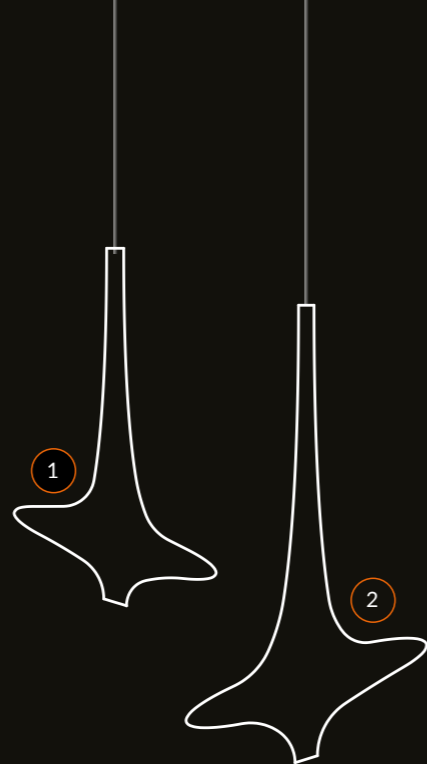

FROSTED OR METALLIZED GOLD HAND-BLOWN GLASS PENDANT.

2 shapes available: ① h. 23 - ø 13 cm. ② h. 29,5 - ø 15,5 cm.



HYDRA

BERRY

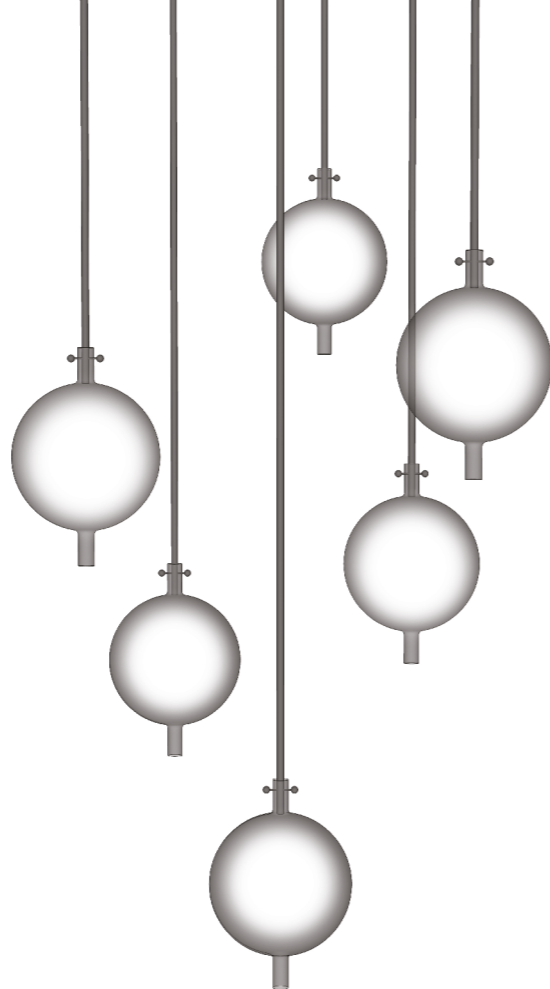

CLEAR HAND-BLOWN GLASS PENDANT.

One size only: h. 24 - ø 16 cm.



HYDRA

BERRY METAL

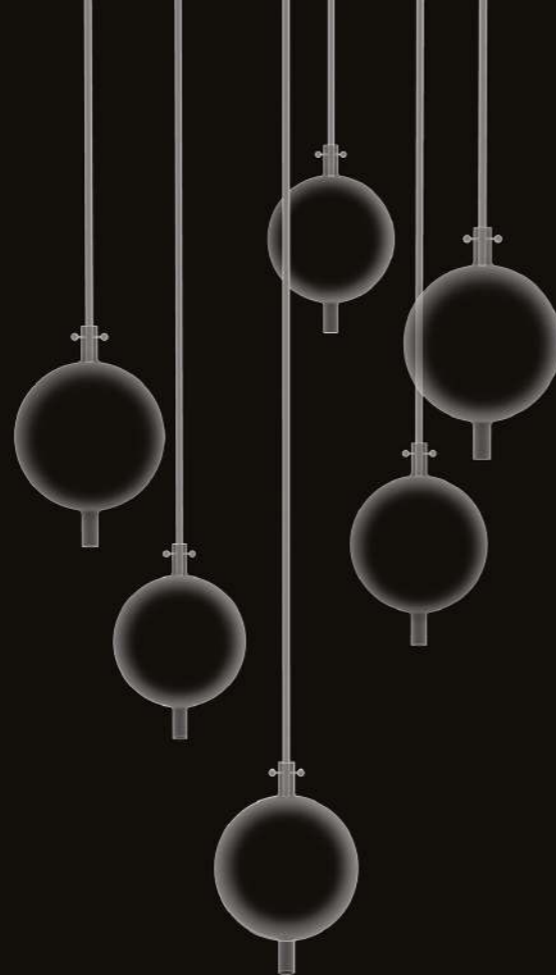

SILVER OR PINK GOLD METALLIZED HAND-BLOWN GLASS PENDANT.

One size only: h. 24 - ø 16 cm.

Additional inner light can be used with this model.





HYDRA

BETA

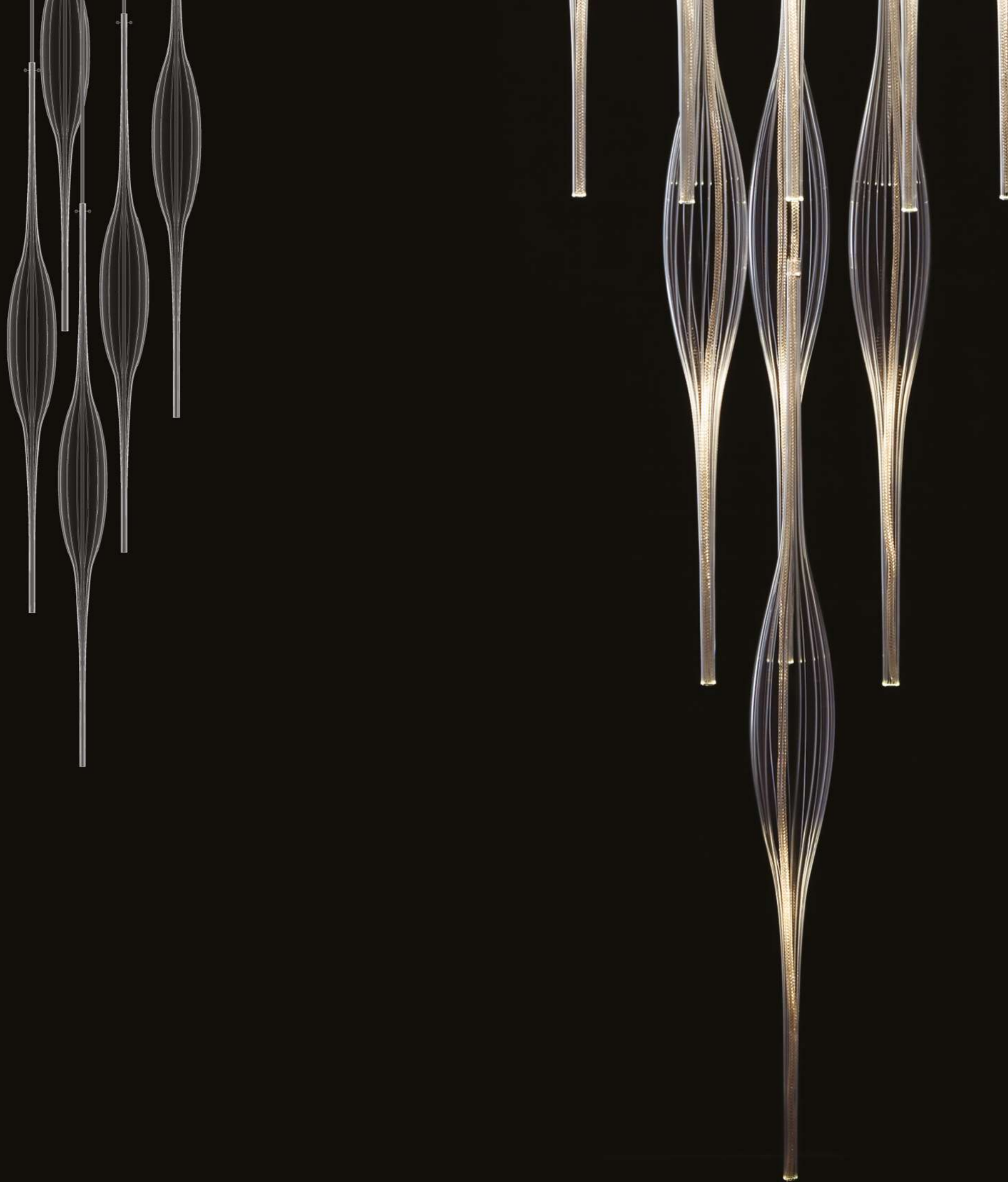

CLEAR OR FROSTED HAND-BLOWN RULED GLASS PENDANT.

One size only: h. 85 - ø 7,5 cm.

Additional inner light can be used with this model (see page 34).



HYDRA

DATURA

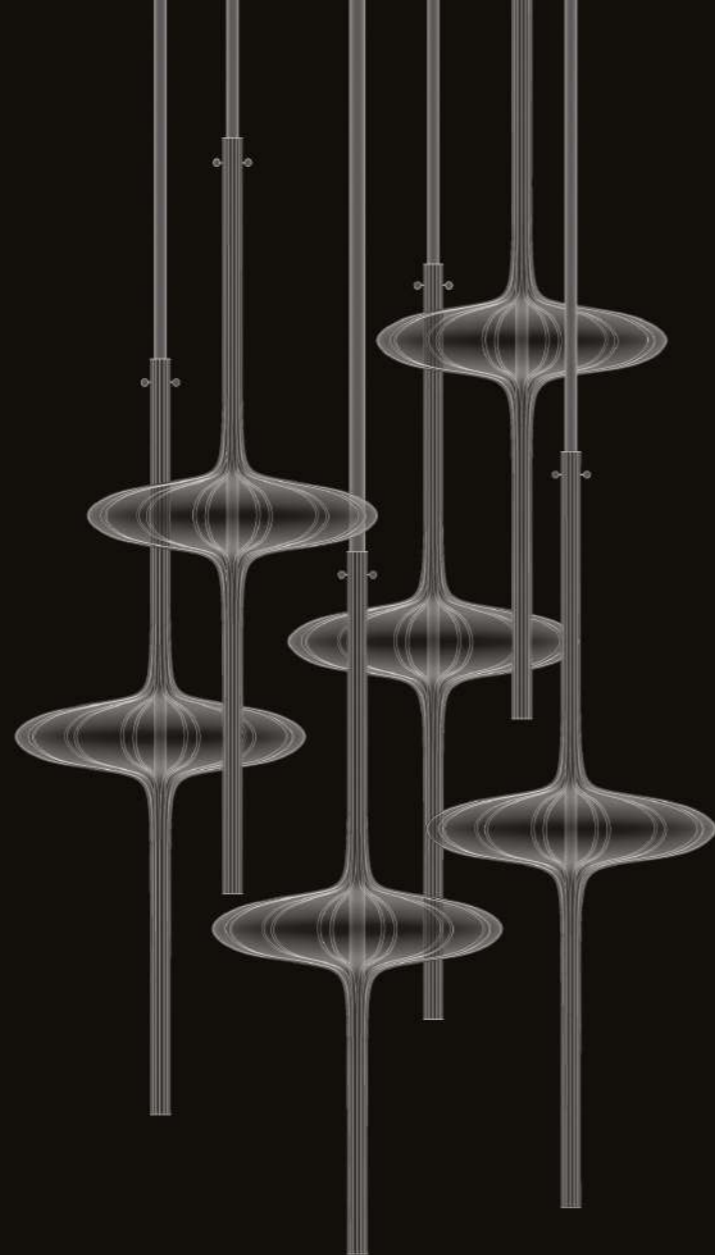

CLEAR OR FROSTED HAND-BLOWN RULED GLASS PENDANT.

One size only: h. 48 - ø 18 cm.

Additional inner light can be used with this model (see page 34).



HYDRA

DELTA

FROSTED HAND-BLOWN GLASS PENDANT.

One size only: h. 50 - ø 6,5 cm.

Additional inner light can be used with this model (see page 34).



HYDRA

DERVISCI

CLEAR OR FROSTED RULED BLOWN GLASS PENDANT.

3 shapes available: ① h. 38,5 - ø 12 cm. ② h. 48,5 - ø 16 cm. ③ h. 58,5 - ø 21 cm.

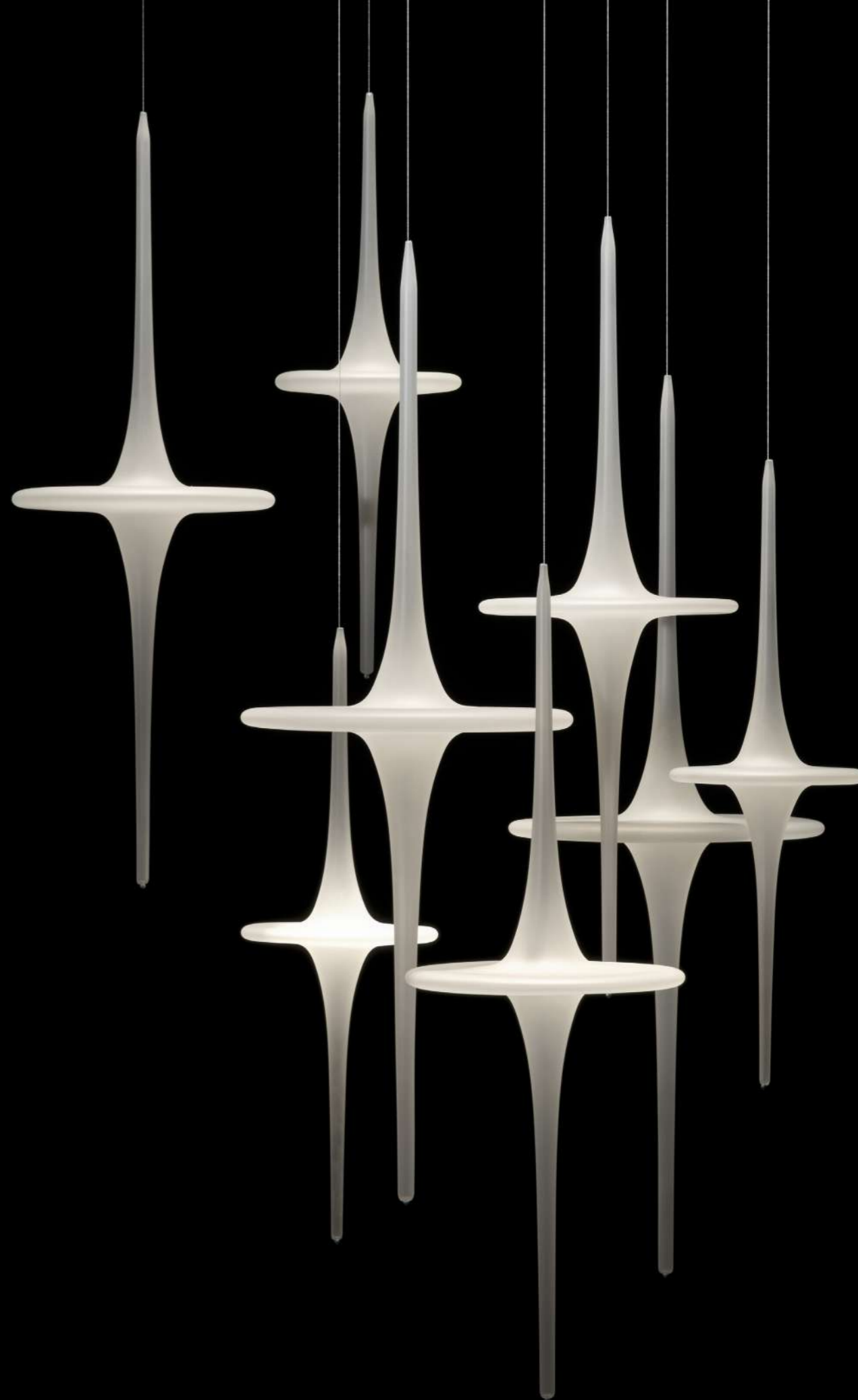

HYDRA

DIESIS

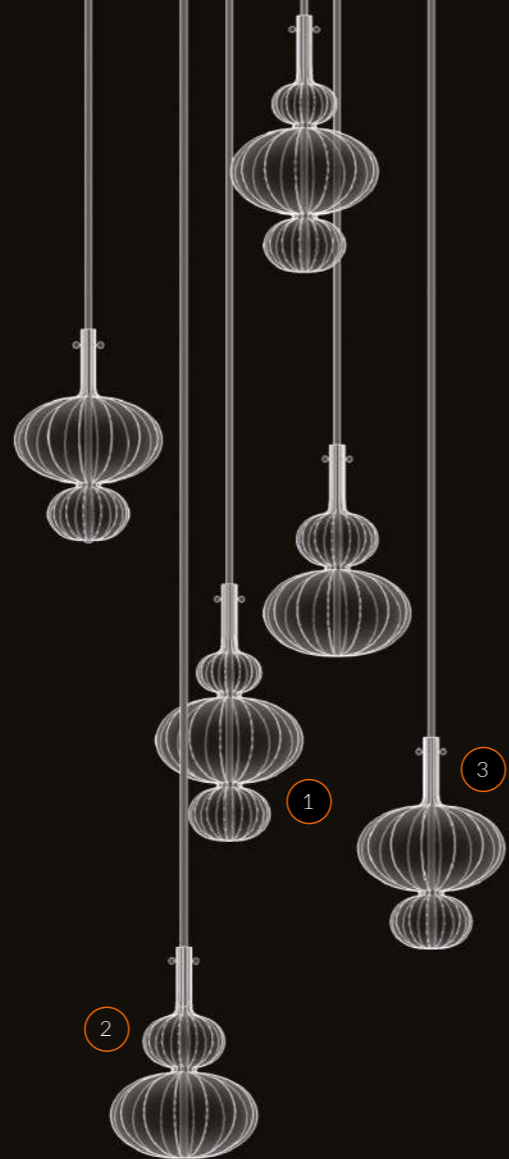

CLEAR, FROSTED OR METALLIZED HAND-BLOWN RULED GLASS PENDANT.

3 shapes available: ① h. 31 - ø 18 cm. ② h. 26 - ø 18 cm. ③ h. 26 - ø 18 cm.
Additional inner light can be used with this model.



HYDRA

GAMMA

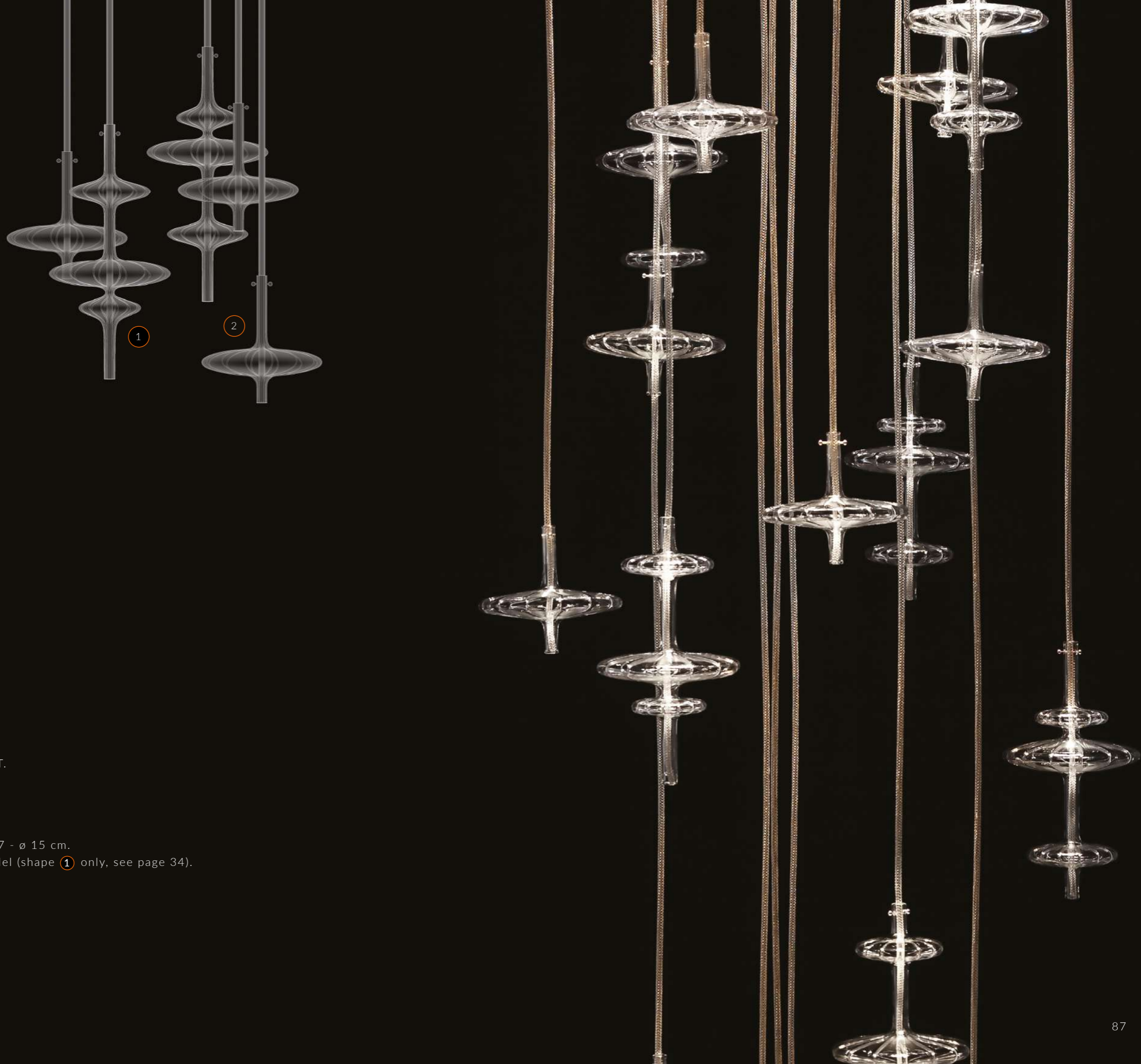

CLEAR HAND-BLOWN RULED GLASS PENDANT.

2 shapes available: ① h. 30 - ø 15 cm. ② h. 17 - ø 15 cm.

Additional inner light can be used with this model (shape ① only, see page 34).





HYDRA

LAMBDA



CLEAR OR FROSTED HAND-BLOWN RULED GLASS PENDANT.

One size only: h. 31 - ø 10,5 cm.



HYDRA

LHASA

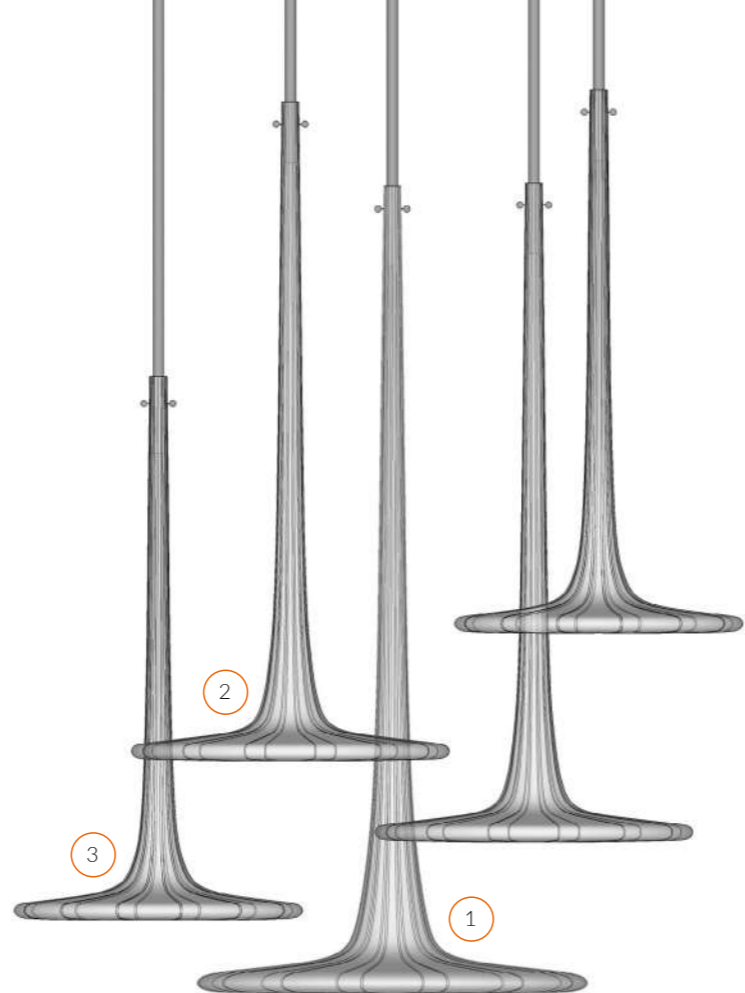

CLEAR OR FROSTED HAND-BLOWN RULED GLASS PENDANT.

3 sizes available: ① h. 56 - ø 27 cm ② h. 45 - ø 22 cm ③ h. 37 - ø 20 cm.



HYDRA

OMEGA

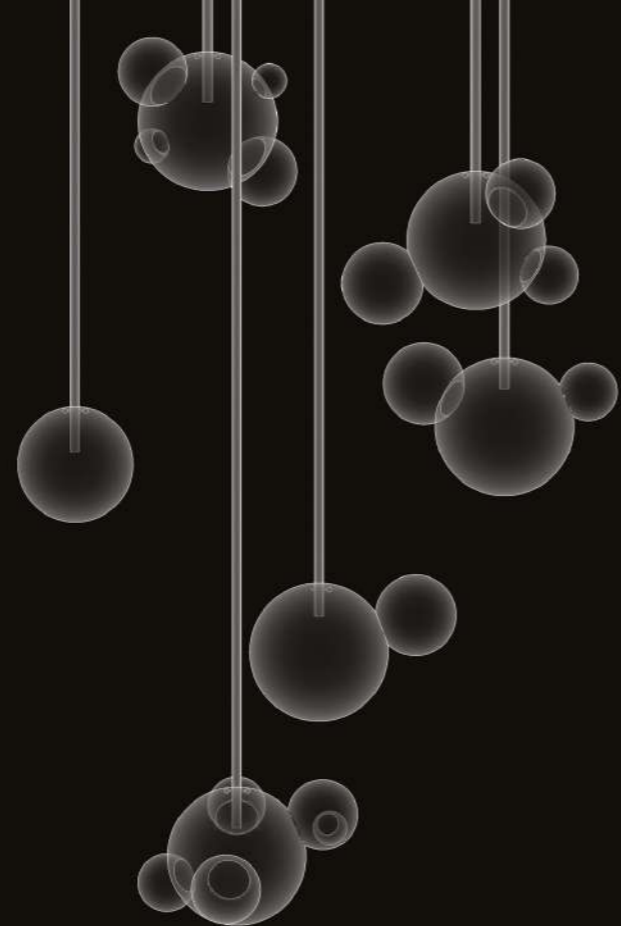

CLEAR HAND-BLOWN GLASS PENDANT.

8 shapes available. From \varnothing 8 up to \varnothing 23 cm.





THE BEAUTY OF
NATURAL IMPERFECTION

HYDRA

ONION

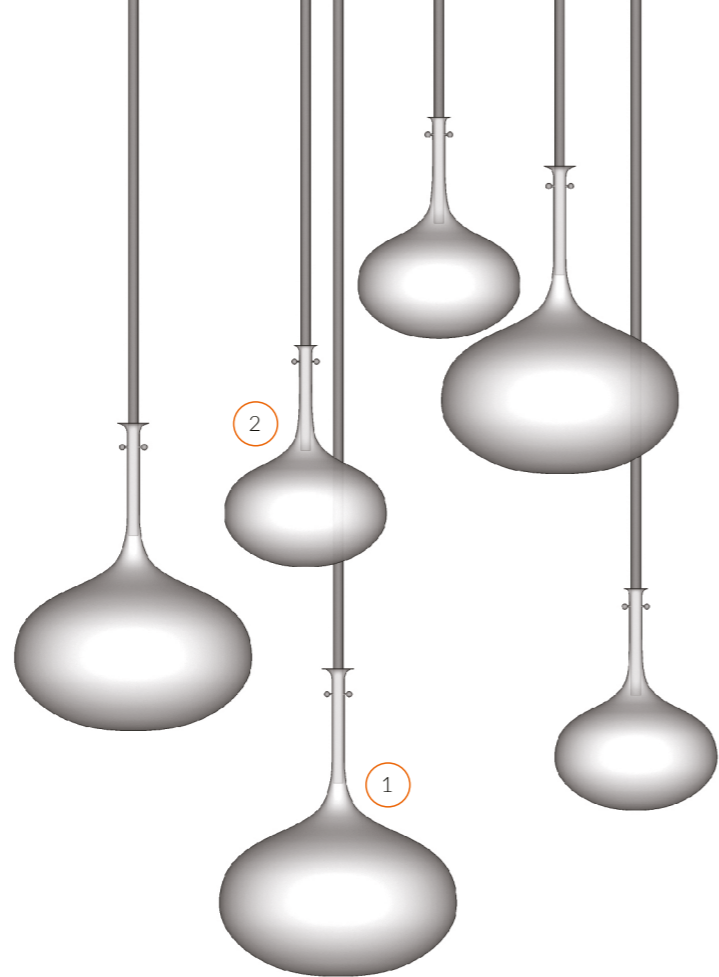

FROSTED HAND-BLOWN GLASS PENDANT.

2 sizes available: ① h. 25 - ø 19 cm. ② h. 18 - ø 13 cm.



HYDRA

ORGANIC

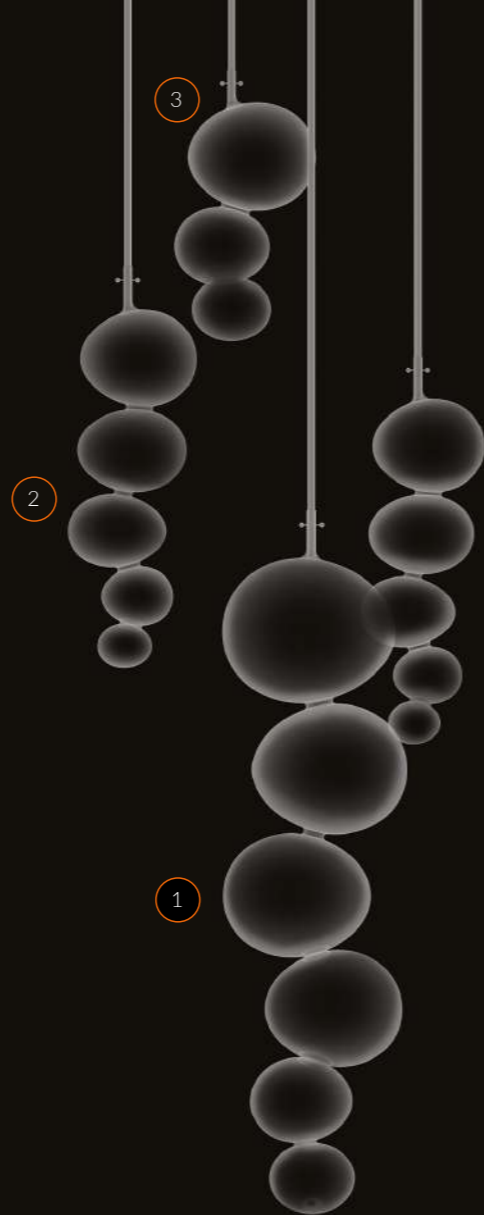

CLEAR OR METALLIZED HAND-BLOWN GLASS PENDANT.

3 shapes available: ① h. 70 - ø 18 cm. ② h. 50 - ø 15 cm. ③ h. 30 - ø 18 cm.



HYDRA

SIGMA

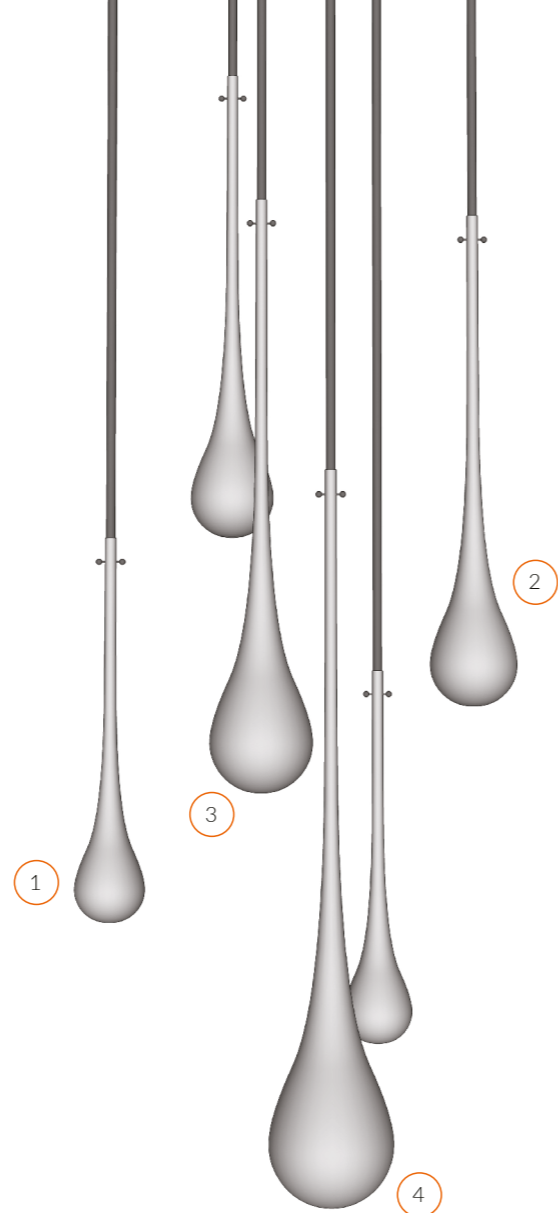

CLEAR OR FROSTED HAND-BLOWN GLASS PENDANT.

4 sizes available: ① h. 35 - ø 7 cm. ② h. 45 - ø 8 cm. ③ h. 55 - ø 9 cm. ④ h. 65 - ø 11 cm.



LED CEILING LIGHTS

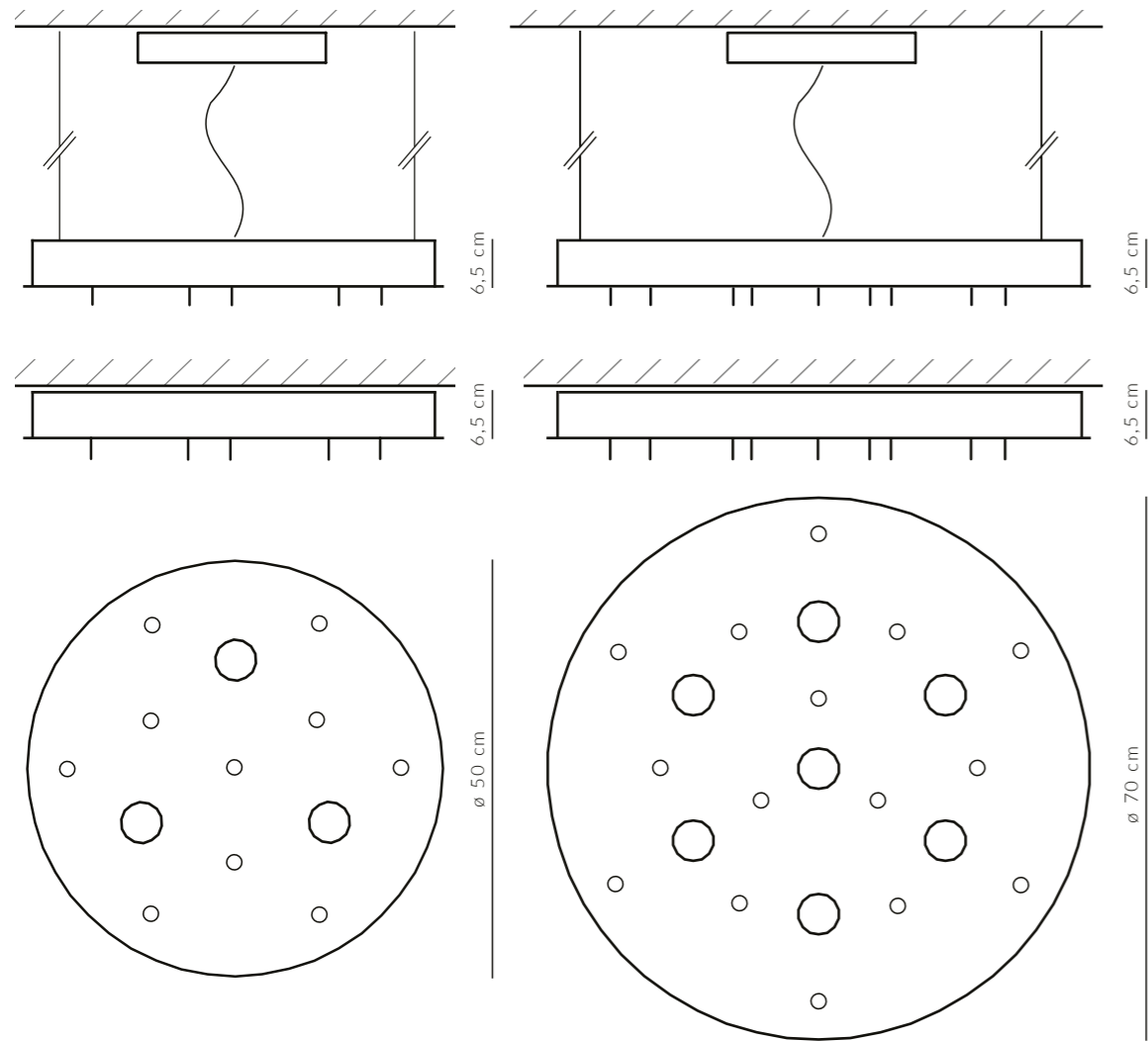

ROUND METAL CEILING.

SMALL_ø 50 cm. Varnished or mirror finishing.
3 x 10W power LED dimmable, 2700k optic 10°.
10 fixing supports for metallic mesh ropes.

LARGE_ø 70 cm. Varnished or mirror finishing.
7 x 10W power LED dimmable, 2700k optic 10°.
15 fixing supports for metallic mesh ropes.

melogranoblu can design and produce customized ceiling lights.



CREDITS

COPYRIGHT

© 2024 by melogranoblu srl



CATALOGUE DESIGN

BABOL COMMUNICATION
www.babolcommunication.com

