







melogranoblu

LIGHTING CATALOGUE

melogranoblu  
LIGHTING CATALOGUE

# LEGEND

	CLEAR GLASS
	FROSTED GLASS
	RULED CLEAR GLASS
	RULED FROSTED GLASS
	METALLIZED GLASS
	METALLIZED RULED GLASS
	INNER LIGHT
	REFLECTED LIGHT
	SUSPENSION LAMP
	WALL LAMP
	TABLE LAMP
	FLOOR LAMP

# INDEX

<b>CALAMUS &amp; BAMBOO</b>	<b>10</b>	<b>AU</b>	<b>74</b>
CALAMUS 100	12	AU   SUSPENSION	74
CALAMUS 136	14	AU   TABLE	76
BAMBOO	16		
<b>PIERO</b>	<b>18</b>	<b>PERFUME</b>	<b>78</b>
PIERO   DOME	20	PERFUME EGG	80
PIERO   CYLINDER	20	PERFUME PINECONE	82
		PERFUME SPHERE	84
		PERFUME SPEAR	86
<b>SULEYMAN &amp; MAHIDEVRAN</b>	<b>22</b>		
SULEYMAN   SUSPENSION	24	<b>API - MAAT - BES</b>	<b>88</b>
SULEYMAN   TABLE	26	API   SUSPENSION	90
MAHIDEVRAN	28	MAAT   SUSPENSION	92
		BES   SUSPENSION	94
<b>COKE</b>	<b>30</b>	MAAT   TABLE	96
		BES   TABLE	98
<b>SEMI</b>	<b>32</b>	<b>GOTHAM</b>	<b>100</b>
<b>SOAP</b>	<b>34</b>	<b>DIAPASON</b>	<b>104</b>
SOAP SPHERE	36	DIAPASON A   CHANDELIER	106
SOAP DOME   TABLE	38	DIAPASON A   WALL	108
SOAP DOME   SUSPENSION	40	DIAPASON B   SUSPENSION	110
		DIAPASON C   SUSPENSION	112
		DIAPASON C   WALL	114
<b>SERENDIPITY</b>	<b>42</b>		
SERENDIPITY   SUSPENSION	42	<b>OPERA</b>	<b>116</b>
SERENDIPITY   TABLE	44	TURANDOT	118
		CARMEN	119
<b>RAPA NUI</b>	<b>46</b>	DROP	120
		POSEIDON EGG	121
<b>OPIUM</b>	<b>50</b>	POSEIDON GLOBE	122
		ZUCCA	123
<b>GHANTA</b>	<b>52</b>	BAJADERE	124
GHANTA (BROWN)	54	CALAF	125
GHANTA (CLEAR)	56	NINIVE	126
		TIMUR	127
<b>ARTUSI</b>	<b>58</b>	LIU "A"	128
ARTUSI #01, #02, #03	60	LIU "B"	129
		LIU "C"	130
<b>GALUCHAT</b>	<b>62</b>	MOON	131
GALUCHAT   TABLE	64		
GALUCHAT   SUSPENSION	66	ACCESSORIES	132
		TASSELS AND CABLES	133
<b>BARTOLOMEO</b>	<b>68</b>		
BARTOLOMEO   SUSPENSION	70		
BARTOLOMEO   TABLE	72		

## THE FACTORY OF EMOTIONS

CONCEIVED AND FOUNDED IN 1997 BY ERMANNO ROCCHI AND MASSIMO CREMA, MELOGRANOBLU IS AN ITALIAN INTERIOR LIGHTING COMPANY. OVER THE YEARS, THE COMPANY HAS DEVELOPED A WIDE RANGE OF SOLUTIONS FOR INTERIOR LIGHTING DESIGN, SUITABLE FOR HOMES OR OFFERING MORE IMPRESSIVE INSTALLATIONS FOR LARGE ARCHITECTURAL SETTINGS.

MELOGRANOBLU CREATIONS ARE VERITABLE SPECTACLES OF LIGHT, FOCUSING ON THE SENSORY AND EMOTIONAL EFFECT OF LIGHT THROUGH GLASS.

DESIGN PROJECTS IN WHICH ALL FORMS OF GLASS ARE CONCEIVED AND DESIGNED ACCORDING TO THE EFFECTS THEY CAN GENERATE THROUGH LIGHT.

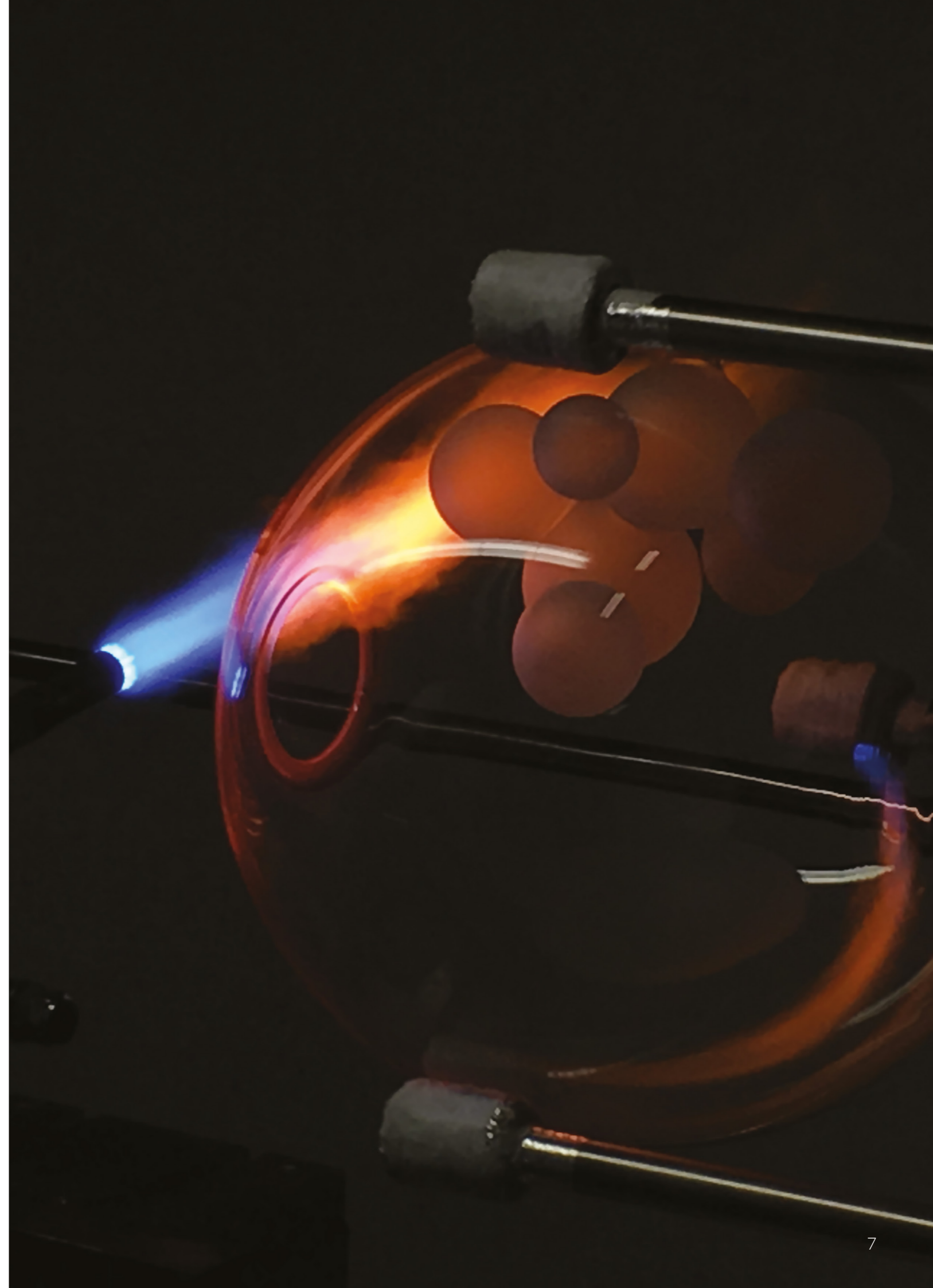

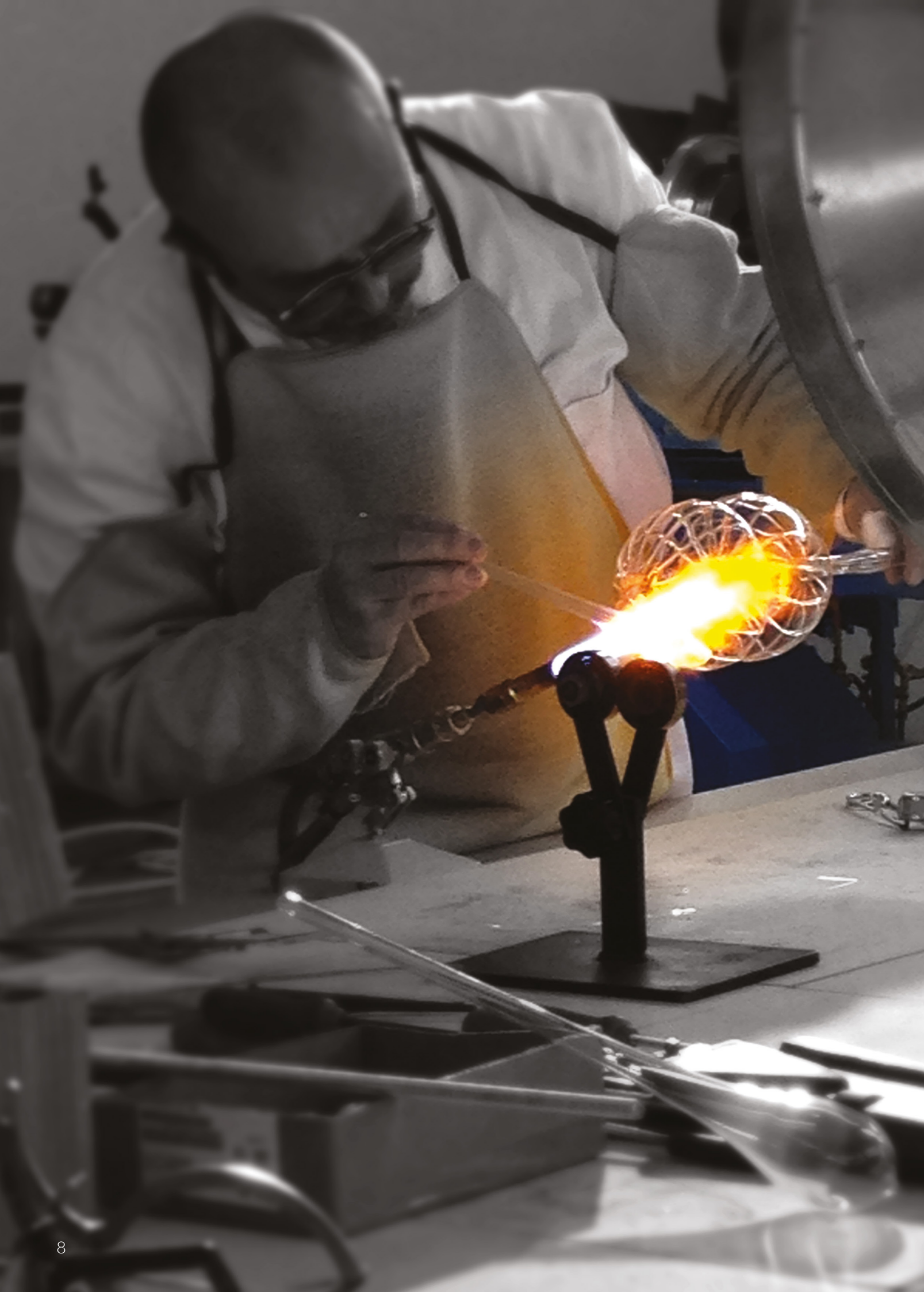

## CRAFTED PRODUCTION AND INDUSTRIAL ORGANISATION

ALL MELOGRANOBLU DESIGNS ARE CONCEIVED, DEVELOPED, ENGINEERED AND PRODUCED IN THE COMPANY. A STRUCTURE ORGANISED TO MANAGE AND GUARANTEE "MADE IN ITALY" QUALITY THROUGHOUT THE ENTIRE PRODUCTION PROCESS.

UNIQUE PIECES, THE SAME YET DIFFERENT SINCE THEY ARE MADE WITH PASSION BY SKILLED HANDS THAT CREATE ARTWORKS FROM GLASS.

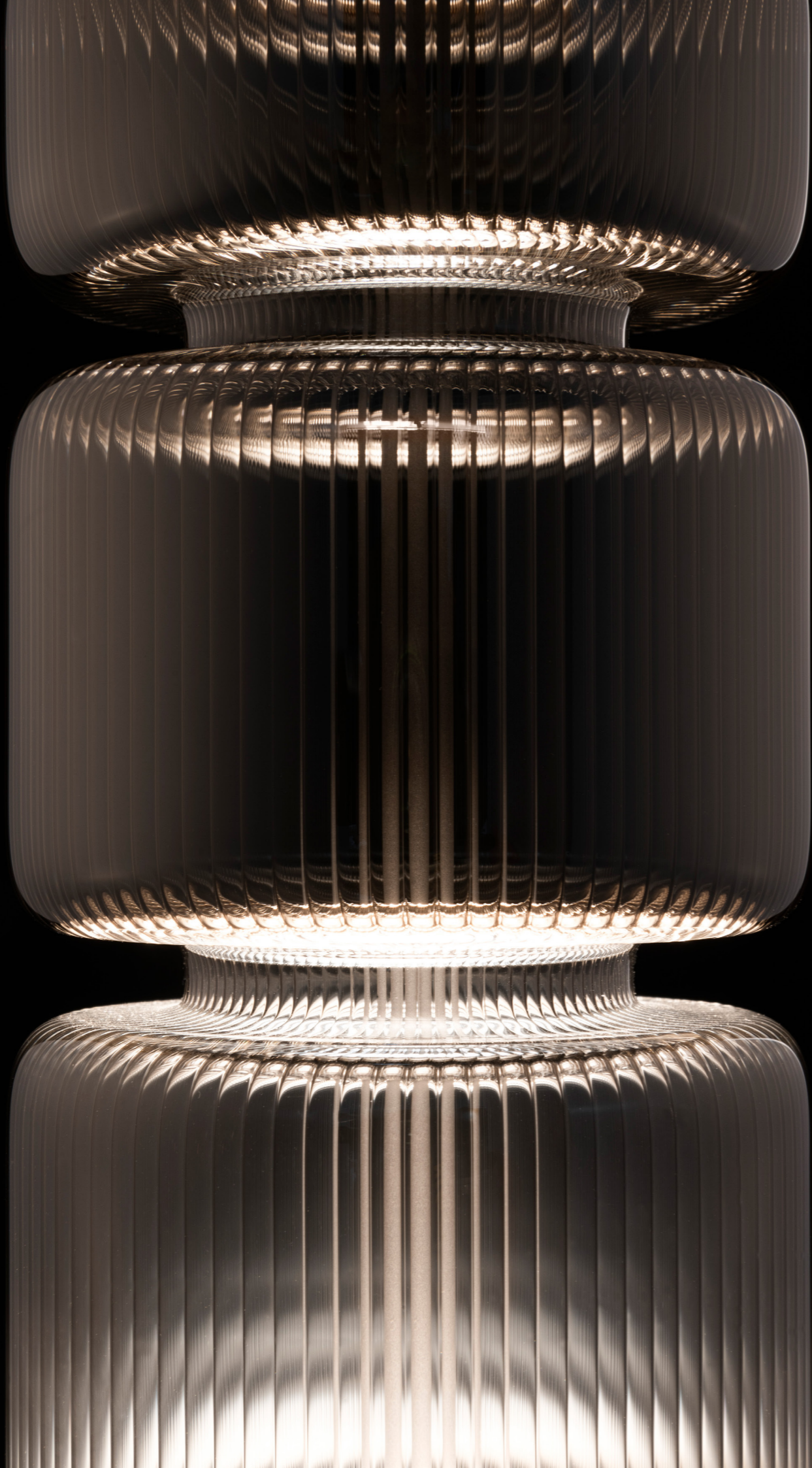

## CALAMUS & BAMBOO

DERIVED FROM OBJECTS MADE OF THE SAME MATERIAL, CALAMUS AND BAMBOO ARE TWO HAND-BLOWN RULED GLASS SHAPE SUSPENSION LAMPS. CALAMUS, INSPIRED BY AN ANCIENT WRITING INSTRUMENT, ALSO FEATURES TWO VERSIONS, ONE 100MM AND THE OTHER 136MM.

# CALAMUS 100

SUSPENSION LAMP

METALLIZED TITANIUM OR CLEAR  
HAND-BLOWN RULED GLASS SHAPE

Glass dimension  $\varnothing$  10 cm. h 65 cm.

Dual light source: 7 watt, LED module - 2700k + 3 watt LED module with lens 10° 2700k.

Metal parts varnished DARK GREY.

Electric cable 2 mt length coated 21 Black.



# CALAMUS 136



SUSPENSION LAMP

CLEAR  
HAND-BLOWN RULED GLASS SHAPE

Glass dimension  $\varnothing$  13,6 cm. h 65 cm.  
Dual light source: 7 watt, LED module - 2700k + 3 watt LED module with lens 10° 2700k.  
Metal parts varnished DARK GREY.  
Electric cable 2 mt length coated 21 Black.

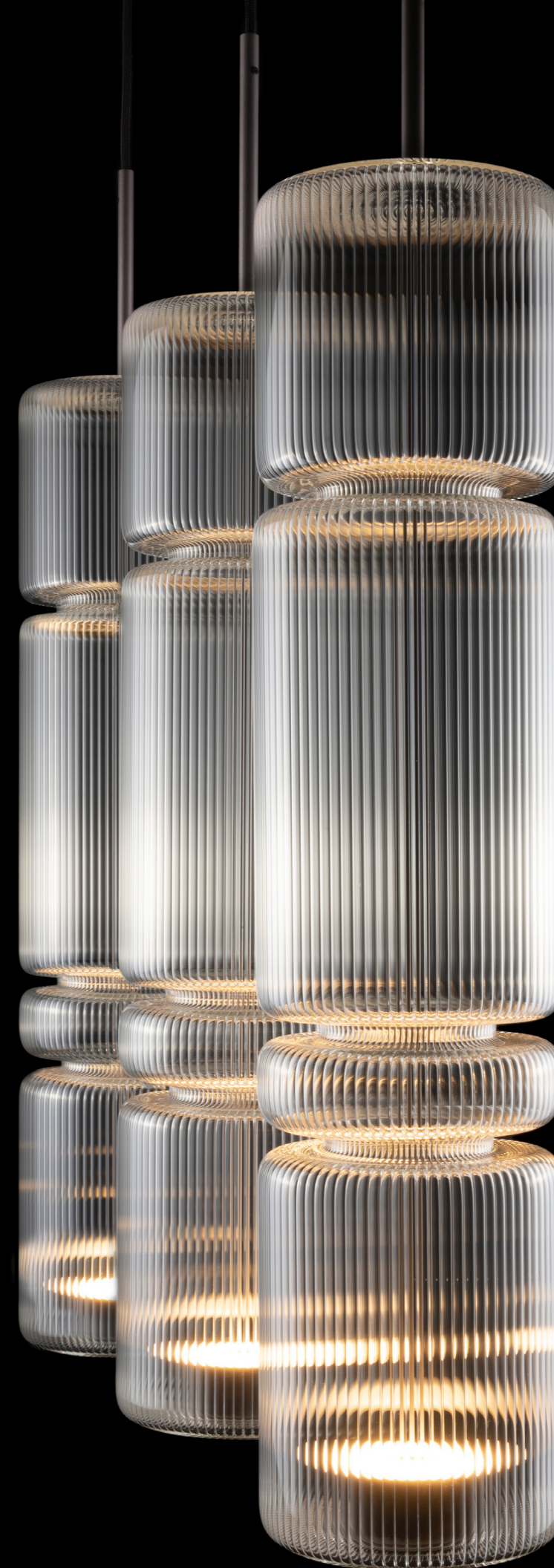
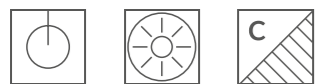



# BAMBOO



SUSPENSION LAMP

CLEAR OR FROSTED  
HAND-BLOWN RULED GLASS SHAPE

Glass dimension  $\varnothing$  8 cm. h 65 cm.  
Dual light source: 7 watt, LED module - 2700k + 3 watt LED module with lens 10° 2700k.  
Metal parts varnished DARK GREY.  
Electric cable 2 mt length coated 21 Black.

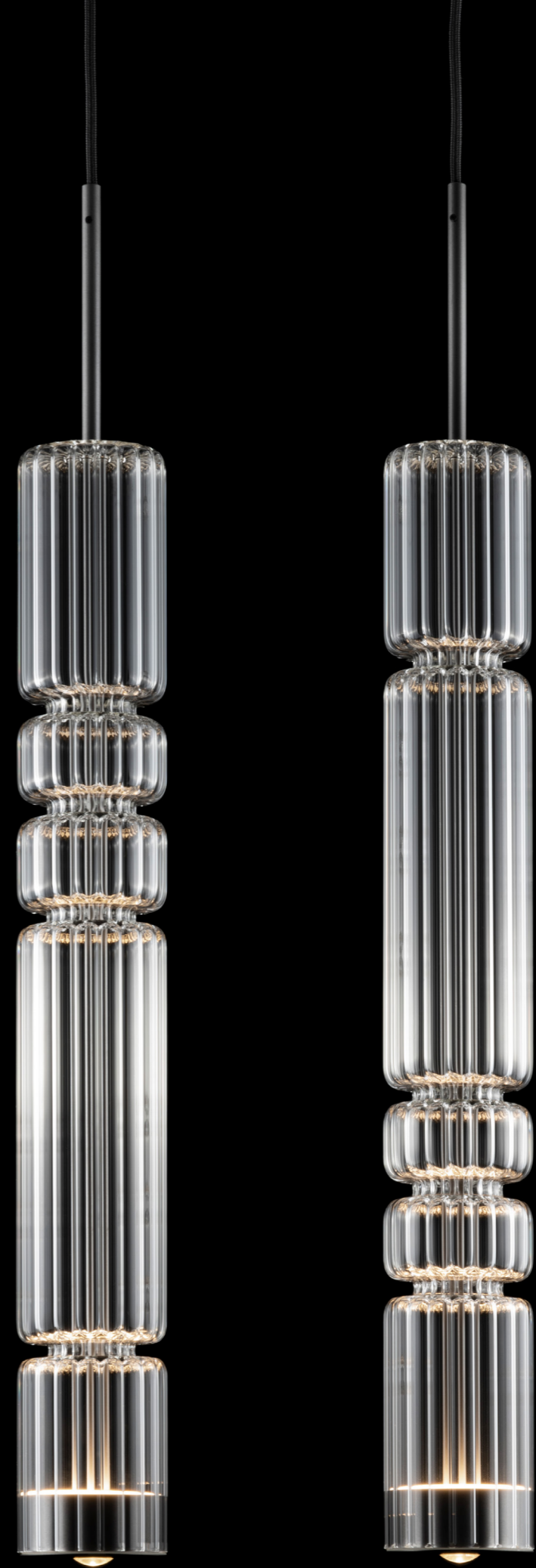
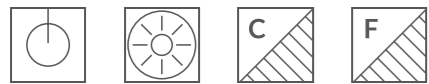



## PIERO

WHEN ART MEETS DESIGN, THIS HAND-BLOWN GLASS SUSPENSION LAMP IS BORN. INSPIRED BY ONE OF PIERO DELLA FRANCESCA'S MOST FAMOUS WORKS, THE BRERA ALTARPIECE, PIERO FEATURES AN INNER FROSTED GLASS EGG.

# PIERO DOME & CYLINDER



SUSPENSION LAMP

CLEAR OR METALLIZED  
HAND-BLOWN RULED GLASS SHAPE WITH INNER FROSTED GLASS EGG

Glass dimension:

1 ø 13 cm, h. 37 cm.

2 ø 18 cm, h. 32 cm.

Dual light source: 7 watt, LED module - 2700k + 3 watt LED module with lens 10° 2700k.

Metal parts varnished DARK GREY.

Electric cable 2 mt length coated 21 Black.



2

1

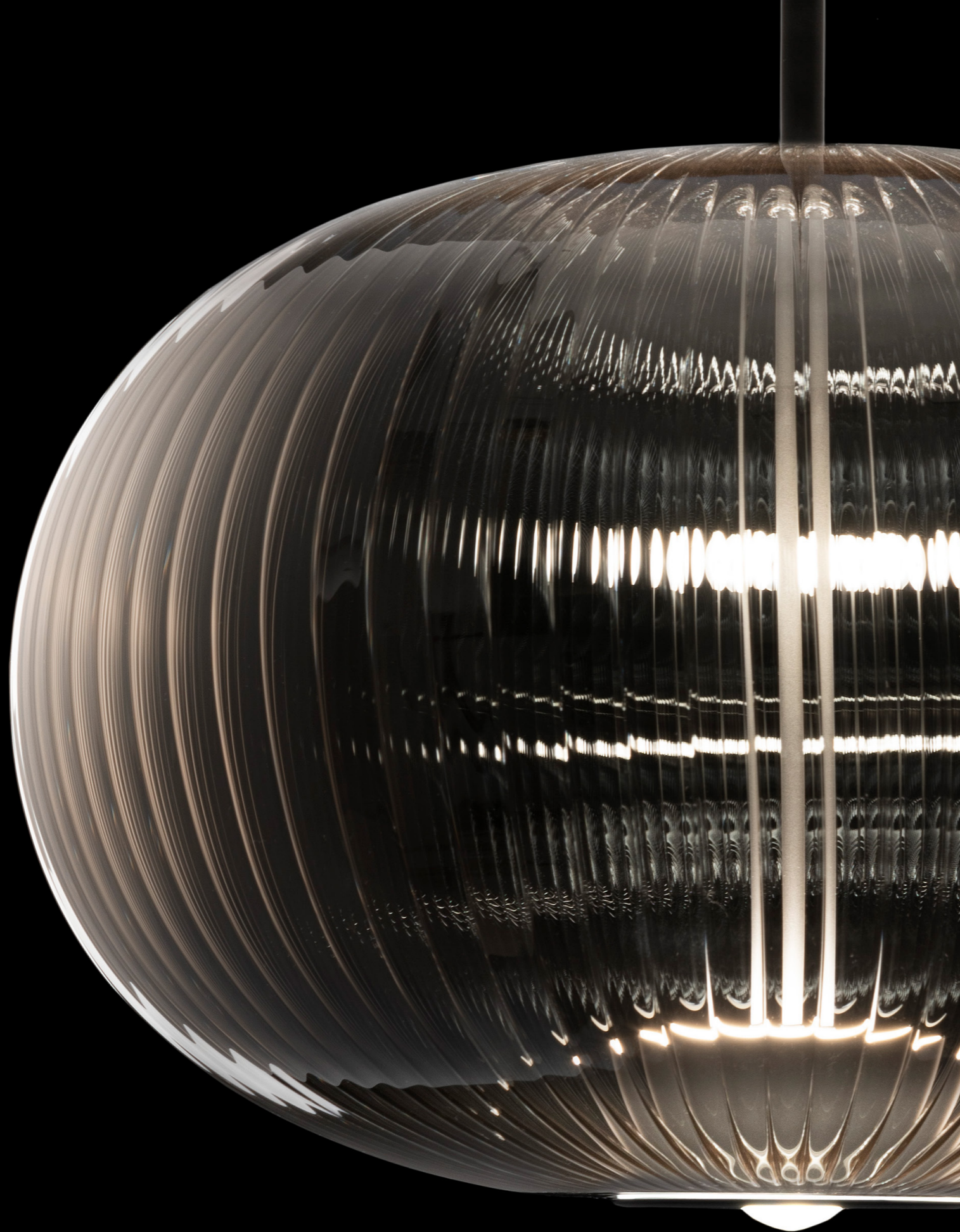

## SULEYMAN & MAHIDEVRAN

INSPIRED BY THE SILHOUETTES OF THE HEADRESSES OF OTTOMAN SULTAN SULEYMAN 'THE MAGNIFICENT', AND HIS FAVOURITE CONCUBINE, SULEYMAN AND MAHIDEVRAN ARE HAND-BLOWN RULED GLASS SHAPE LAMPS.

# SULEYMAN

## SUSPENSION LAMP

METALLIZED TITANIUM OR CLEAR  
HAND-BLOWN RULED GLASS SHAPE

Glass dimension  $\varnothing$  35 cm. h. 23 cm.  
Dual light source: 7 watt, LED module - 2700k + 3 watt LED module with lens 10° 2700k.  
Metal parts varnished DARK GREY.  
Electric cable 2 mt length coated 21 Black.



# SULEYMAN

TABLE LAMP

METALLIZED TITANIUM OR CLEAR  
HAND-BLOWN RULED GLASS SHAPE

Glass dimension  $\varnothing$  35 cm. h. 23 cm.  
Dual light source: 7 watt, LED module - 2700k dimmer control.  
Metal parts varnished DARK GREY.  
Electric cable 2 mt length coated 21 Black.

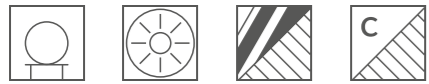

# MAHIDEVRAN

SUSPENSION LAMP

CLEAR OR FROSTED  
HAND-BLOWN RULED GLASS SHAPE

Glass dimension  $\varnothing$  35 cm.  
Dual light source: 7 watt, LED module - 2700k + 3 watt LED module with lens 10° 2700k.  
Metal parts varnished DARK GREY.  
Electric cable 2 mt length coated 21 Black.





# COKE

HAND-BLOWN GLASS FORM IN METALLIC TITANIUM  
WHOSE NAME ECHOES THAT OF ITS GREY COLOUR.

TABLE LAMP

METALLIZED TITANIUM  
HAND-BLOWN GLASS SHAPE

Glass dimension  $\varnothing$  25 cm. h. 19 cm.  
Dual light source: 7 watt, LED module - 2700k dimmer control.  
Metal parts varnished DARK GREY.  
Electric cable 2 mt length coated 21 Black.





# SEMI

HAND-BLOWN RULED GLASS SHAPE  
IN METALLIZED PURPLE AMETHYST.

TABLE LAMP

METALLIZED PURPLE AMETHYST  
HAND-BLOWN RULED GLASS SHAPE

—

Glass dimension  $\varnothing$  25 cm. h. 19 cm.  
Dual light source: 7 watt, LED module - 2700k dimmer control.  
Metal parts varnished DARK GREY.  
Electric cable 2 mt length coated 21 Black.





## SOAP

TRANSPARENCY IN TRANSPARENCY. SOAP COLLECTION PLAYS WITH THE REVELATORY POWER OF LIGHT. THE GLASS SCULPTURE INSIDE IS REVEALED ONLY WHEN THE LIGHT SOURCE, AS IF BY MAGIC, MAKES THE EXTERNAL MİRRORED ELEMENT TRANSPARENT, CREATING A SUBLIME AND FASCINATING GAME OF APPEARANCES. THE ENERGY RELEASED FROM THE INSIDE IS A MARRIAGE OF TECHNIQUE AND GENIUS.

# SOAP SPHERE



## SUSPENSION LAMP

METALLIZED HAND-BLOWN GLASS SPHERE  
INNER FROSTED BUBBLE SCULPTURE.

Glass dimension  $\varnothing$  30 cm.  
Light source 9 watt LED module - 2700k, driver included.  
Metal parts in brushed brass / black nickel.  
Electric cable 2,00 mt. length coated #21 Black.

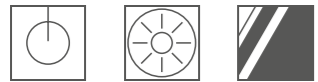

# SOAP DOME

## TABLE LAMP

TRANSPARENT HAND-BLOWN GLASS DOME, INNER TRANSPARENT BUBBLE SCULPTURE  
OR METALLIZED HAND-BLOWN GLASS DOME, INNER FROSTED BUBBLE SCULPTURE.

Glass dimension h. 30 - ø 30 cm.

Light source 9 watt LED module - 2700k, dimmer control.

Metal parts in brushed brass / black nickel.

Electric cable 2,50 mt. length coated #21 Black.



# SOAP DOME

## SUSPENSION LAMP

METALLIZED HAND-BLOWN GLASS DOME,  
INNER FROSTED BUBBLE SCULPTURE.

Glass dimension  $\varnothing$  30 cm.  
Light source 9 watt LED module - 2700k, driver included.  
Metal parts in brushed brass / black nickel.  
Electric cable 2,00 mt. length coated #21 Black.



# SERENDIPITY

ORGANIC, NATURAL AND PRIMORDIAL SHAPES CHARACTERIZE SERENDIPITY. FROSTED GLASS SINGLE UNIT, WHOSE SOFT SHAPE REFLECT THE BEAUTIFUL IMPERFECTION OF NATURE.

SUSPENSION LAMP

FROSTED HAND-BLOWN GLASS.

Glass dimension h. 55 - ø 18 cm.  
Light source 4 x 2,5W LED 2800k.  
Electric cable 2,00 mt. length coated metallic mesh Copper T00.



# SERENDIPITY

TABLE LAMP

FROSTED HAND-BLOWN GLASS.

Glass dimension h. 55 - ø 18 cm.

Light source 4 x 2,5W LED 2800k dimmer control.

Electric cable 2,00 mt. length coated metallic mesh Copper T00.





## RAPA NUI

THINK ABOUT PRIMORDIAL STATUES, BUT IT IS LIGHT GLASS INDEED. A TABLE LAMP WITH GOLD AND STEEL FINISHES AND MIRRORED EFFECTS MIXED WITH A STRONG DESIGN. A TRIUMPH OF SOLIDITY WITH THE TOUCH OF LIGHTNESS OF HAND-BLOWN GLASS.



# RAPA NUI

## TABLE LAMP

METALLIZED SILVER OR GOLD HAND-BLOWN GLASS.

SMALL\_Metallized gold hand-blown glass. Dimension h. 15 - ø 18 cm.  
Light source 1 x 3W LED 2700k dimmer control.  
Metal base varnished dark grey. Electric cable 2,00 mt. length coated #21 Black.

LARGE\_Metallized silver hand-blown glass. Dimension h. 24 - ø 18 cm.  
Light source 1 x 3W LED 2700k dimmer control.  
Metal base varnished dark grey. Electric cable 2,00 mt. length coated #21 Black.



# OPIUM

FROM NATURE, THIS IS A PORTRAIT OF REALITY. THIS SUSPENDED LAMP MADE WITH GOLD METALLIZED HAND-BLOWN GLASS, WHOSE SHAPE LOOKS LIKE A POPPY CAPSULE, IS THE PICTURE OF NATURAL BEAUTY.



SUSPENSION LAMP

GOLD METALLIZED HAND-BLOWN GLASS.

Glass dimension h. 19 - ø 20 cm.  
Light source 1xG9 LED, max 5 watt. Metal parts in brushed brass.  
Electric cable 2,00 mt. length coated #19 Brown.

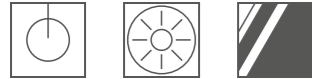



## GHANTA

SUSPENSION LAMP IN BROWN METALLIC GLASS WITH WHITE FROSTED OR GOLD LEAF PENDANT. ITS SHAPE EVOKES THE TYPICAL TIBETAN RITUAL BELLS. IT IS ALSO AVAILABLE IN TRANSPARENT GLASS BELL WITH FROSTED PENDANT VERSION.

# GHANTA

## SUSPENSION LAMP

BROWN METALLIC HAND-BLOWN GLASS DOME  
WITH GLASS PENDANT GOLD LEAF OR FROSTED FINISHING.

Glass dimension  $\varnothing$  19 cm, h. 45 cm.

Light source 7 watt, LED module - 2700 K, driver included.

Metal parts varnished Dark Grey. Electric cable 2 mt. length coated #21 Black.

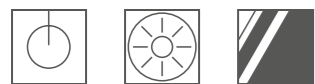

# GHANTA

## SUSPENSION LAMP

CLEAR HAND-BLOWN GLASS DOME  
WITH GLASS PENDANT GOLD LEAF OR FROSTED FINISHING.

Glass dimension  $\varnothing$  19 cm, h. 45 cm.

Light source 7 watt, LED module - 2700 K, driver included.

Metal parts varnished Dark Grey. Electric cable 2 mt. length coated #21 Black.





## ARTUSI

A SUSPENSION LAMP WITH A DOUBLE BELL SHAPE AND A METALLIC PINK COPPER EXTERNAL FINISH THAT RECALLS HAUTE CUISINE EQUIPMENT. INSIDE IT HIDES A SECOND BELL IN WHITE FROSTED RULED GLASS. AVAILABLE IN THREE SIZES, WITH DIFFERENT HEIGHTS AND DIAMETERS.

# ARTUSI

## SUSPENSION LAMP

PINK COPPER METALLIC HAND-BLOWN GLASS DOME  
INNER FROSTED GLASS SHAPE.

Glass dimension:

- 1 ø 13 cm, h. 49 cm.
- 2 ø 18 cm, h. 28 cm.
- 3 ø 25 cm, h. 19 cm.

Light source 1xG9 LED, max 5 watt.

Metal parts varnished Dark Grey, Electric cable 2 mt. length coated #21 Black.

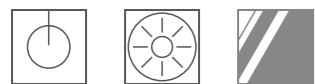

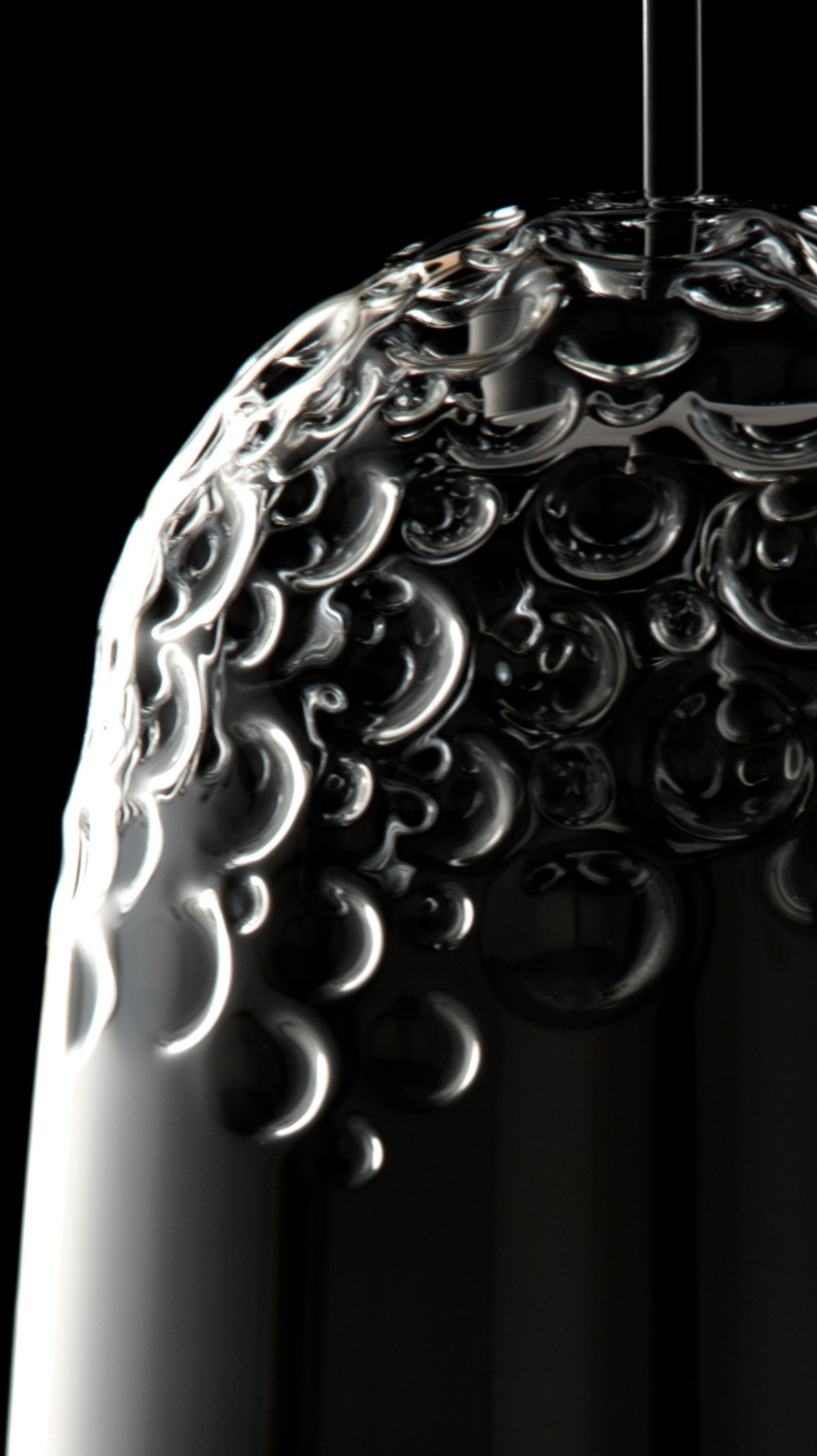

## GALUCHAT

SUSPENSION AND TABLE LAMP IN TRANSPARENT BLOWN GLASS WITH OPAQUE ANTHRACITE METAL PAINTED FRAME. THE PRECIOUS HANDWORK MADE IT POSSIBLE TO OBTAIN AN IRREGULAR TEXTURE REMINISCENT OF THE MANUFACTURING OF SHARK TANNED LEATHER, ALSO CALLED "GALUCHAT" FROM THE NAME OF ITS FIRST USER, JEAN-CLAUDE GALUCHAT, A FRENCH CRAFTSMAN AT THE SERVICE OF KING LOUIS XV.



# GALUCHAT

TABLE LAMP

CLEAR HAND-BLOWN GLASS SHAPE.



Glass dimension  $\varnothing$  23 cm, h. 36 cm.

Light source 7 watt, LED module - 2700 K, dimmer control.

Metal parts varnished dark grey. Electric cable 2 mt. length coated #21 Black.



# GALUCHAT



SUSPENSION LAMP

CLEAR HAND-BLOWN GLASS SHAPE.

Glass dimension  $\varnothing$  23 cm, h. 36 cm.

Light source 7 watt, LED module - 2700 K, driver included.

Metal parts varnished Dark Grey. Electric cable 2 mt. length coated #21 Black.





## BARTOLOMEO

ITS BELL-SHAPED CLEAR BLOWN GLASS WITH THREE FROSTED SPHERES IS A TRIBUTE TO BARTOLOMEO COLLEONI, AN HISTORICAL "CONDOTTIERO" FROM BERGAMO (ITALY) OF THE 1400S. AVAILABLE IN BOTH TABLE AND SUSPENSION VERSIONS.

# BARTOLOMEO



SUSPENSION LAMP

CLEAR HAND-BLOWN GLASS DOME WITH FROSTED SPHERES.

Glass dimension  $\varnothing$  18 cm, h. 33 cm.

Light source 7 watt, LED module - 2700 K, driver included.

Metal parts varnished dark grey. Electric cable 2 mt. length coated #21 Black.



# BARTOLOMEO

TABLE LAMP

CLEAR HAND-BLOWN GLASS DOME WITH FROSTED SPHERES.

Glass dimension  $\varnothing$  18 cm, h. 33 cm.

Light source 7 watt, LED module - 2700 K, dimmer control.

Metal parts varnished dark grey. Electric cable 2 mt. length coated #21 Black.

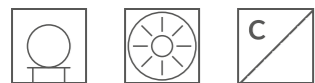



AU

SUSPENSION AND TABLE LAMP MADE OF GOLD METALLIC BLOWN GLASS: A SOFT, HEAVY, DUCTILE AND MALLEABLE METAL WHOSE SYMBOL IS AU, FROM THE LATIN "AURUM".

SUSPENSION LAMP

GOLD METALLIZED HAND-BLOWN GLASS DOME.

---

Glass dimension  $\varnothing$  18 cm, h. 33 cm.  
Light source 7 watt, LED module - 2700 K, driver included.  
Metal parts varnished Dark Grey. Electric cable 2 mt. length coated #21 Black.



AU

TABLE LAMP

GOLD METALLIZED HAND-BLOWN GLASS DOME.

Glass dimension  $\varnothing$  18 cm, h. 33 cm.

Light source 7 watt, LED module - 2700 K, dimmer control.

Metal parts varnished Dark Grey. Electric cable 2 mt. length coated #21 Black.

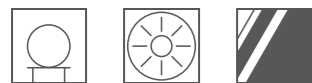



## PERFUME

PENDANT LAMPS THAT TRANSCEND THEIR LIGHTING FUNCTION TO AROUSE EMOTION, GENERATED BY A SPECTACLE OF LIGHTS AND REFLECTIONS. PURE GLASS SHAPES, ESSENTIAL STYLE. POETRY OF LIGHT THAT GAINS EXPRESSION IN A SIMPLE, LINEAR DESIGN. CRAFTED PRODUCTION WHOSE IDENTITY LIES ON THE BORDER BETWEEN DESIGN AND APPLIED ART.



# PERFUME EGG

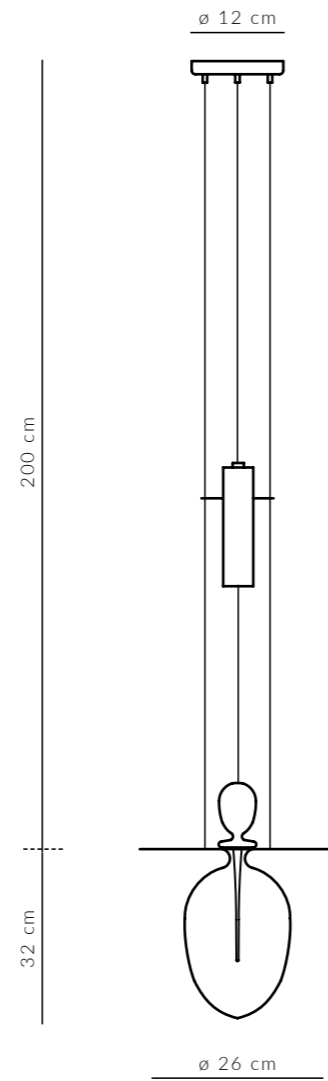

## SUSPENSION LAMP

TRANSPARENT HAND-BLOWN GLASS EGG SHAPE.

Glass dimension h. 32 -  $\varnothing$  26 cm, light source 3W LED 2800k. Metal parts in brushed aluminium. Complete with decorative glass cap available in transparent, frosted, platinum and gold finishing.



# PERFUME PINECONE

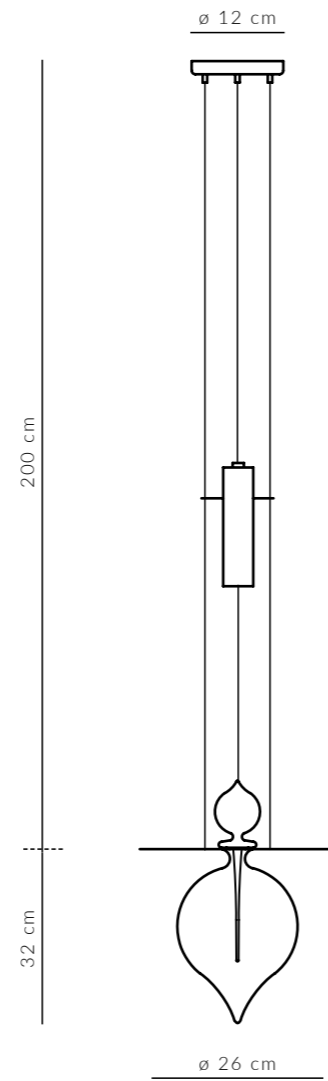

## SUSPENSION LAMP

TRANSPARENT HAND-BLOWN GLASS PINECONE SHAPE.

Glass dimension h. 32 -  $\varnothing$  26 cm, light source 3W LED 2800k. Metal parts in brushed aluminium. Complete with decorative glass cap available in transparent, frosted, platinum and gold finishing.



# PERFUME SPHERE

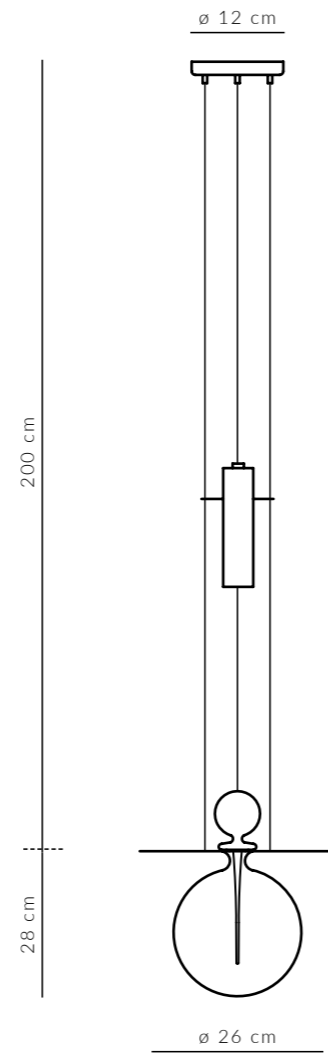

## SUSPENSION LAMP

TRANSPARENT HAND-BLOWN GLASS SPHERE SHAPE.

Glass dimension h. 28 -  $\varnothing$  26 cm, light source 3W LED 2800k. Metal parts in brushed aluminium. Complete with decorative glass cap available in transparent, frosted, platinum and gold finishing.

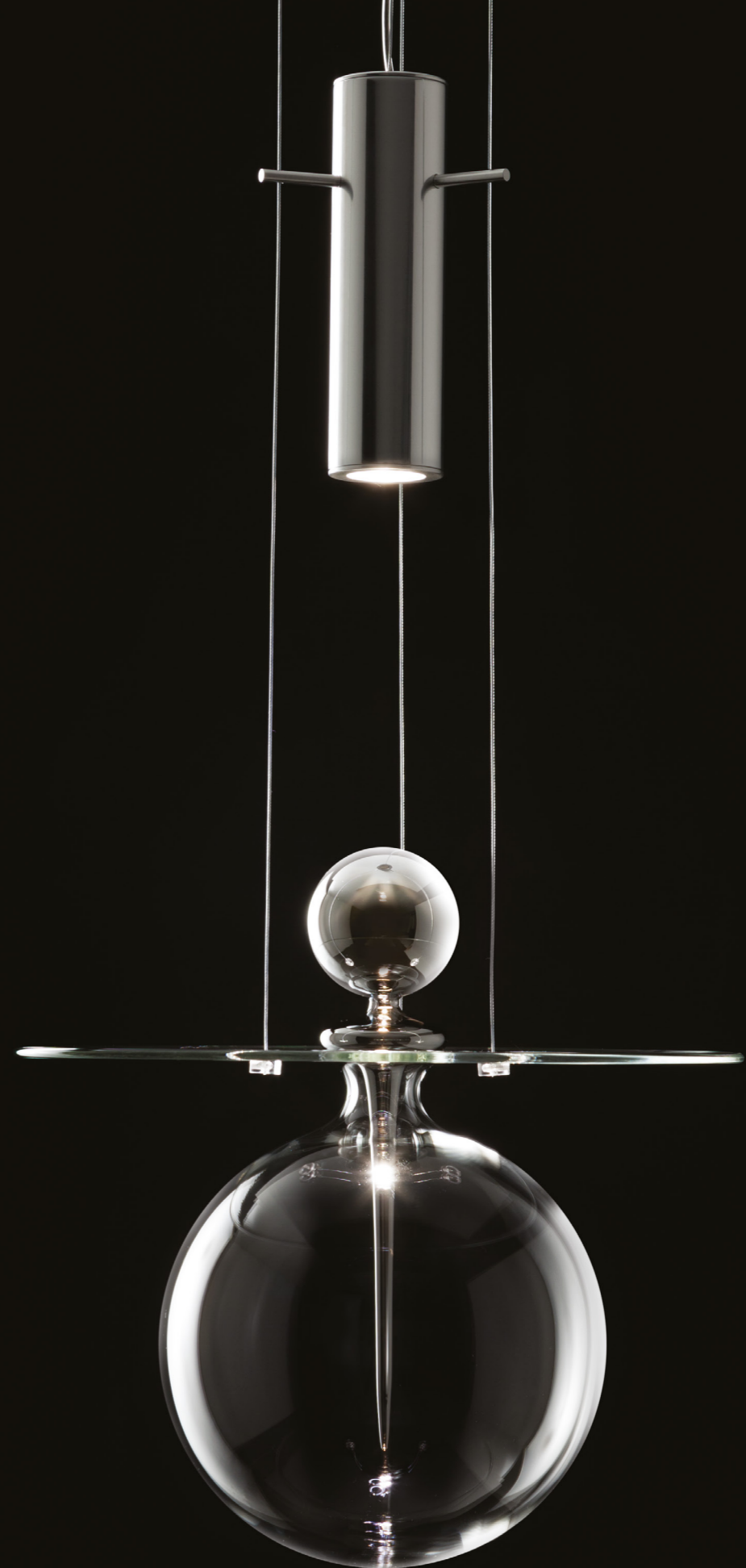

# PERFUME SPEAR

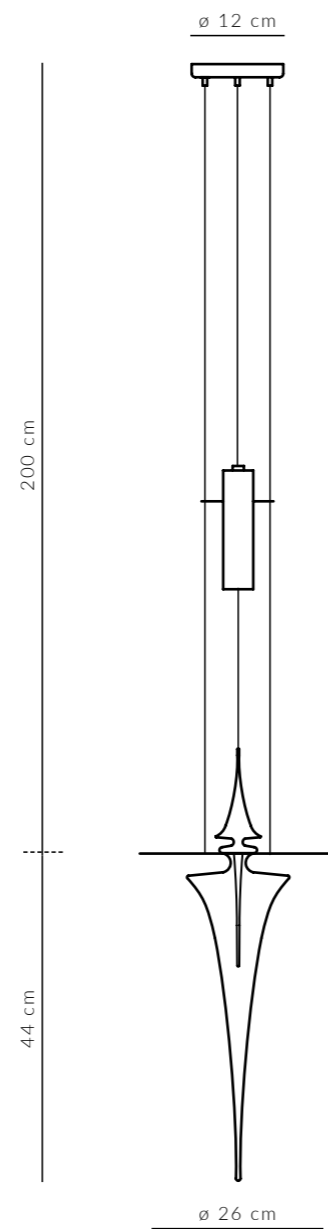

## SUSPENSION LAMP

TRANSPARENT HAND-BLOWN GLASS SPEAR SHAPE.

Glass dimension h. 44 -  $\varnothing 26$  cm, light source 3W LED 2800k. Metal parts in brushed aluminium. Complete with decorative glass cap available in transparent, frosted, platinum and gold finishing.





## API - MAAT - BES

THE SUSPENSION LAMPS THAT BEAR THE NAME OF ANCIENT DIVINITIES ARE MADE OF BLOWN GLASS CHARACTERIZED BY THIN LINES THAT CREATE A PLEATED EFFECT. IN EMERALD, SAPPHIRE, AMETHYST OR WHITE FROSTED COLORS, THEY ARE ALSO AVAILABLE IN TABLE VERSION.

API



Version with E27 socket

SUSPENSION LAMP

SAPPHIRE BLUE OR FROSTED  
HAND-BLOWN RULED GLASS SHAPE.

Glass dimension  $\varnothing$  14,5 cm, h . 49 cm.

Light source available:

- max 12 watt , 220 V LED (E27 socket).
- 7 watt LED module - 2700k, driver included.

Metal parts varnished Dark Grey. Electric cable 2 mt. length coated #21 Black.

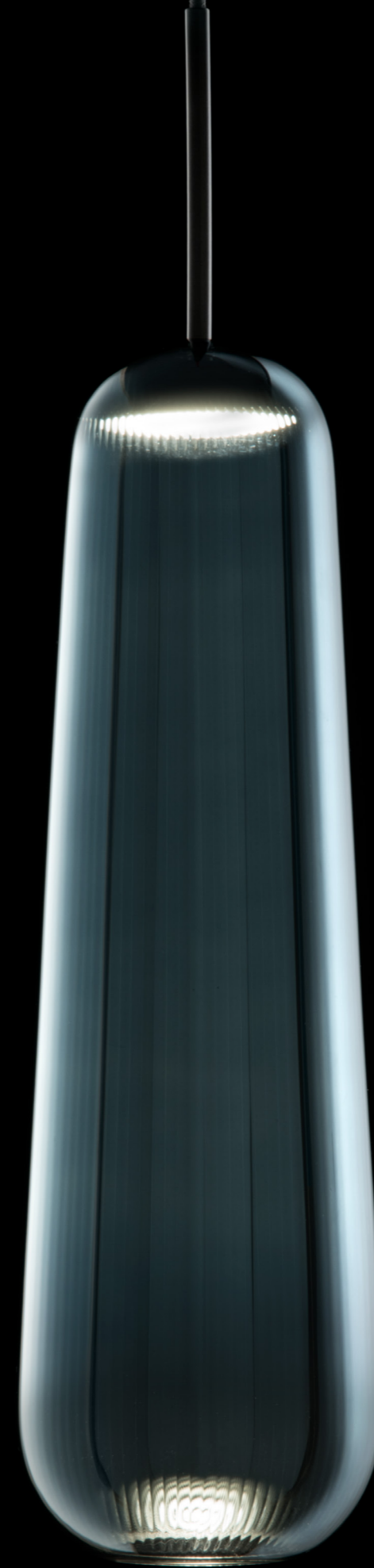

Version with LED module

# MAAT



Version with E27 socket

## SUSPENSION LAMP

EMERALD GREEN OR FROSTED  
HAND-BLOWN GLASS SHAPE.

Glass dimension  $\varnothing$  23 cm, h. 36 cm.

Light sources available:

- max 12 watt , 220 V LED (E27 socket).
- 7 watt LED module - 2700k, driver included.

Metal parts varnished dark grey. Electric cable 2 mt. length coated #21 Black.



Version with LED module



Version with E27 socket



Version with LED module

## BES

SUSPENSION LAMP

PURPLE AMETHYST OR FROSTED  
HAND-BLOWN RULED GLASS SHAPE.

---

Glass dimension  $\varnothing$  27 cm, h. 23 cm.

Light sources available:

- max 12 watt, 220 V LED (E27 socket)
- 7 watt LED module - 2700k, driver included.

Metal parts varnished dark grey. Electric cable 2 mt. length coated #21 Black.







# MAAT

TABLE LAMP

EMERALD GREEN OR FROSTED  
HAND-BLOWN GLASS SHAPE.

Glass dimension  $\varnothing$  23 cm, h. 36 cm.

Light source 7 watt, LED module - 2700 K, dimmer control.

Metal parts varnished dark grey. Electric cable 2 mt. length coated #21 Black.



# BES

TABLE LAMP

PURPLE AMETHYST OR FROSTED  
HAND-BLOWN RULED GLASS SHAPE.

Glass dimension  $\varnothing$  27 cm, h. 23 cm.

Light source 7 watt, LED module - 2700 K, dimmer control.

Metal parts varnished dark grey. Electric cable 2 mt. length coated #21 Black.





## GOTHAM

LIGHTING STRUCTURES, HIGH IMPACT GLASS PENDANT LAMPS, WHOSE DISTINCTIVE CHARACTER PUTS THEM BEYOND ALL DEFINITIONS. METROPOLITAN STYLE, THE DREAM OF A NOCTURNAL MEGALOPOLIS, WHICH ONLY THE MOST VISIONARY IMAGINATION CAN ENVISAGE. AN IMPRESSIVE DESIGN, SOLID AND REASSURING, ENCHANTS THE GAZE AND THE SENSES.

# GOTHAM

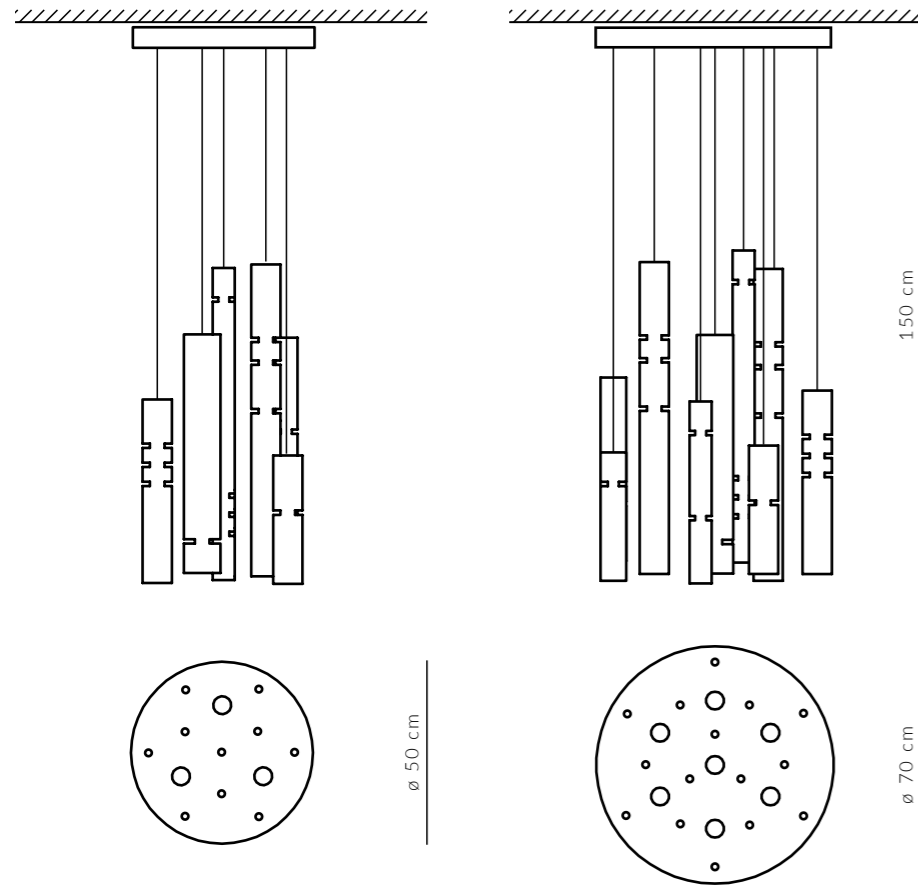

## CHANDELIER

SMALL\_Round metal ceiling  $\varnothing$  50 cm mirror finishing.  
 Light source 3 x 10W power LED dimmable, 2700k optic 10°.  
 10 clear and frosted mixed glass shapes.

LARGE\_Round metal ceiling  $\varnothing$  70 cm mirror finishing.  
 Light source 7 x 10W power LED dimmable, 2700k optic 10°.  
 15 clear and frosted mixed glass shapes.

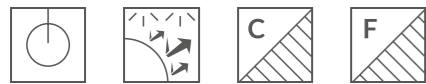



## DIAPASON

VINTAGE SHAPES IN A CONTEMPORARY TRANSPOSITION: A COLLECTION OF SUSPENSION, AND WALL LAMPS INSPIRED BY THE CURVED AND THIN LINES OF THE TUNING FORK. A COMBINATION OF TWO NOBLE MATERIALS: BRUSHED NATURAL BRASS AND FROSTED GLASS. THE CURVES OF THE GLASS AND THE DESIGN OF THE STRUCTURE CREATE SUBTLE BALANCE GAMES. THE DIAPASON COLLECTION IS DESIGNED BY THE DESIGNER GIORGIO SORESSI FOR MELOGRANOBLO.

# DIAPASON A

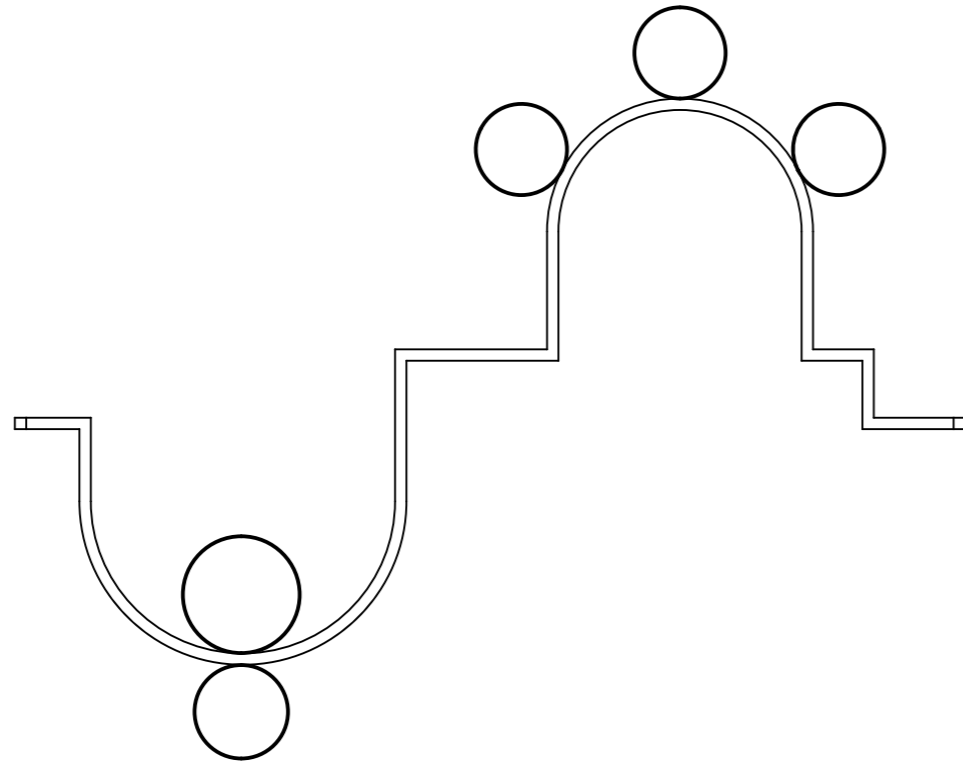

## CHANDELIER

BRUSHED BRASS STRUCTURE WITH FROSTED RULED GLASSES.

Dimension lenght 135 cm, h. 107 cm.

Light source 5 x G9, 220 V, max 6 watt LED. Electric cable 2 mt length black.

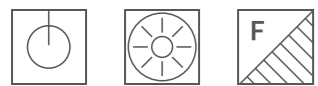

# DIAPASON A

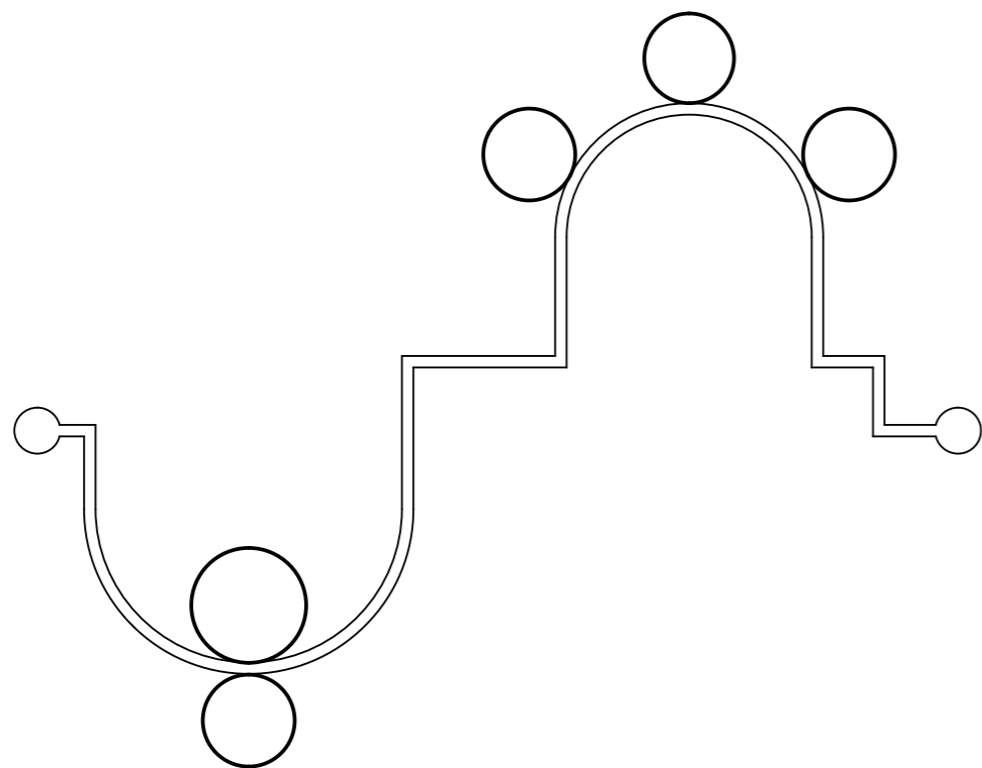

WALL LAMP

BRUSHED BRASS STRUCTURE WITH FROSTED RULED GLASSES.

Dimension lenght 135 cm, h. 107 cm jut 28 cm.  
Light source 5 x G9, 220 V, max 6 watt LED.



# DIAPASON B

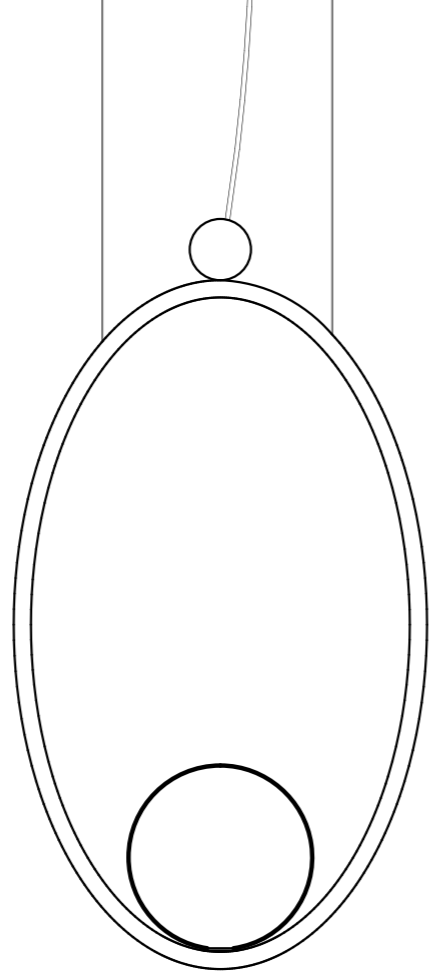

SUSPENSION LAMP

BRUSHED BRASS STRUCTURE WITH FROSTED RULED GLASS.

Dimension width 42 cm, h. 72 cm.

Light source 1 x G9, 220 V, max 6 watt LED. Electric cable 2 mt length black.

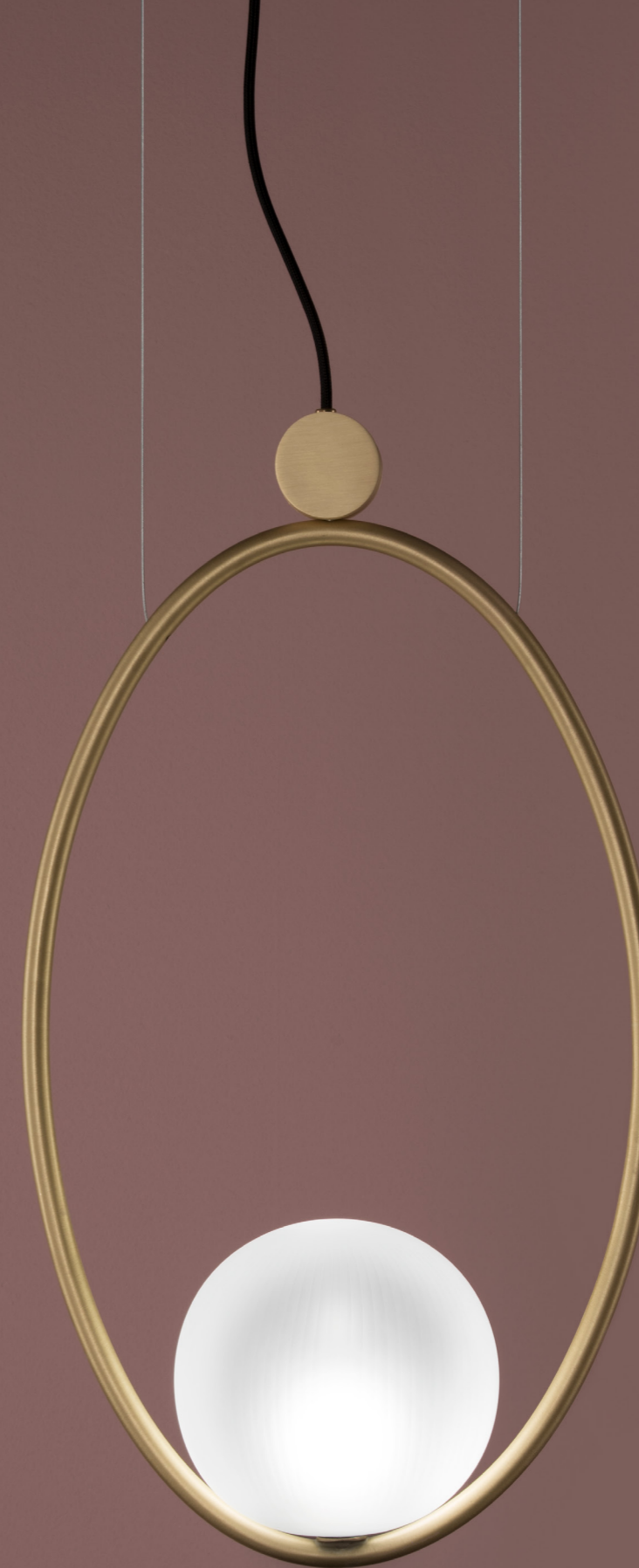
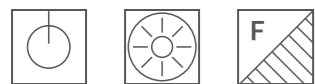

Also available in  
wall version.



# DIAPASON C

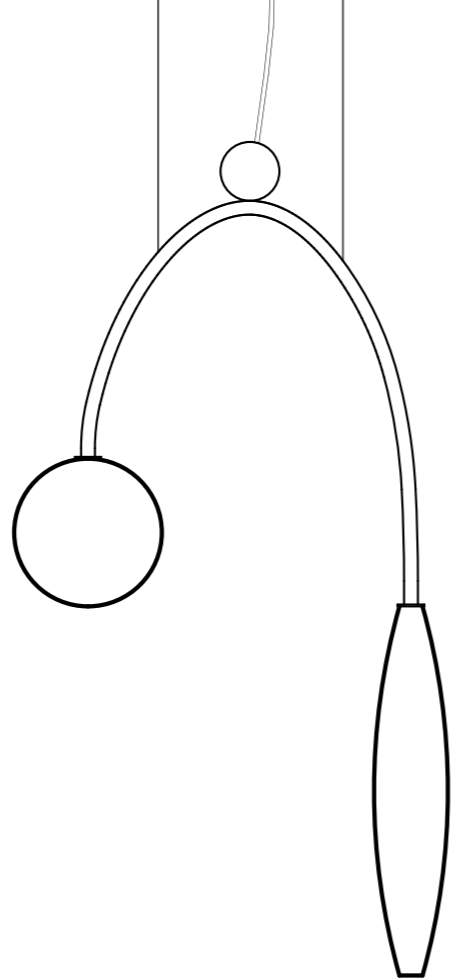

SUSPENSION LAMP

BRUSHED BRASS STRUCTURE WITH FROSTED RULED GLASSES.

Dimension width 60 cm, h. 112 cm.

Light source 2 x G9, 220 V, max 6 watt LED. Electric cable 2 mt length black.

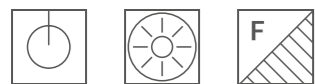

# DIAPASON C

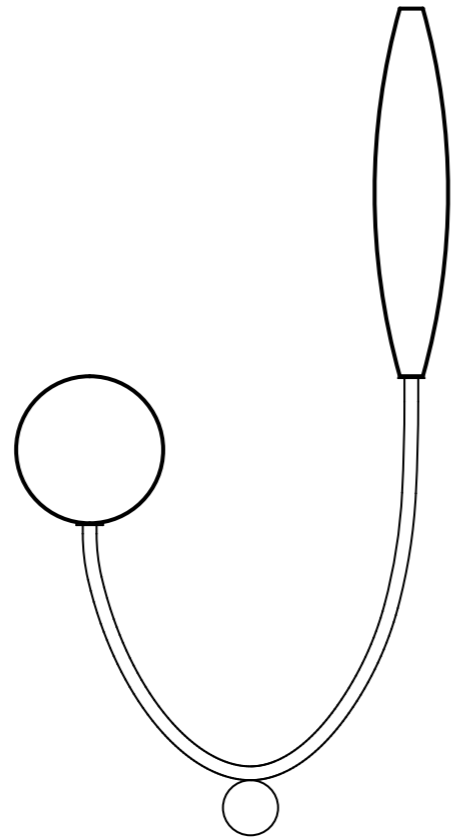

WALL LAMP

BRUSHED BRASS STRUCTURE WITH FROSTED RULED GLASSES.

Dimension width 60 cm, h. 112 cm.  
Light source 2 x G9, 220 V, max 6 watt LED.





## OPERA

COLLECTION OF DECORATIVE PENDANT LAMPS, OBJECTS RICH IN EVOCATIVE ELEMENTS AND LOADED WITH MEMORIES. ICONIC DESIGNS, CAPABLE OF CREATING "FIN DE SIÈCLE" HINTS AND ATMOSPHERES. UNUSUAL YET FAMILIAR FORMS, REASSURING YET CAPABLE OF ASTONISHING. A CONTEMPORARY CLASSIC, ECLECTIC IN STYLE AND AT THE SAME TIME DISCREET ENOUGH TO SUIT ALL SETTINGS.

OPERA

# TURANDOT



HANGING-LAMP, RULED HAND-BLOWN GLASS TRANSPARENT OR FROSTED WITH 40 CM. LENGTH TASSEL INCLUDED, ALSO AVAILABLE IN WALL VERSION.

Cable 2,00 mt. length transparent or coated fabric as per color chart.  
Light source E14. Glass dimension: Large h. 72 - ø 16 cm. | Small h. 50 - ø 14 cm.

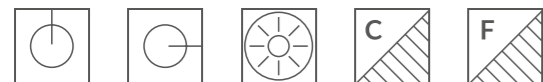

OPERA

# CARMEN



HANGING-LAMP, RULED HAND-BLOWN GLASS TRANSPARENT OR FROSTED WITH 40 CM. LENGTH TASSEL INCLUDED, ALSO AVAILABLE IN WALL VERSION.

Cable 2,00 mt. length transparent or coated fabric as per color chart.



OPERA

## DROP



HANGING-LAMP, HAND-BLOWN GLASS FROSTED.

Cable 2,00 mt. lenght transparent or coated fabric as per color chart.

Light source E14. Glass dimension: h. 65 - ø 13 cm.



OPERA

## POSEIDON EGG



HANGING-LAMP, RULED HAND-BLOWN GLASS TRANSPARENT OR FROSTED WITH 40 CM. LENGHT TASSEL INCLUDED, ALSO AVAILABLE IN WALL VERSION.

Cable 2,00 mt. lenght transparent or coated fabric as per color chart.



OPERA

## POSEIDON GLOBE



HANGING-LAMP, RULED HAND-BLOWN GLASS TRANSPARENT OR FROSTED WITH 40 CM. LENGHT TASSEL INCLUDED, ALSO AVAILABLE IN WALL VERSION.

Cable 2,00 mt. lenght transparent or coated fabric as per color chart.  
Light source E14. Glass dimension: Large ø 23 cm. | Small ø 17 cm.

Also available with glass coral branch not included color Black \_ Ivory \_ Red.

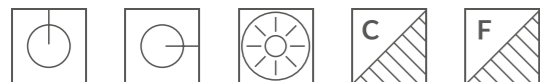

OPERA

## ZUCCA



HANGING-LAMP, RULED HAND-BLOWN GLASS TRANSPARENT OR FROSTED.

Cable 2,00 mt. lenght transparent or coated fabric as per color chart.  
Light source E14. Glass dimension: h. 60 - ø 20 cm.

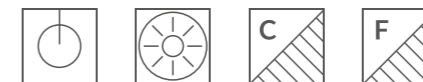

OPERA

## BAJADERE



HANGING-LAMP, RULED HAND-BLOWN GLASS.

Cable 2,00 mt. lenght transparent or coated fabric as per color chart.

Light source E14. Glass dimension: Small h. 50 - ø 11 cm. | Medium h. 60 ø 13 cm. | Large h. 70 - ø 16 cm.

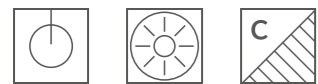

OPERA

## CALAF



HANGING-LAMP, RULED HAND-BLOWN GLASS TRANSPARENT OR FROSTED WITH 40 CM. LENGHT TASSEL INCLUDED, ALSO AVAILABLE IN WALL VERSION.

Cable 2,00 mt. lenght transparent or coated fabric as per color chart.

Light source E14. Glass dimension: Large h. 67 - ø 18 cm. | Small h. 46 - ø 14 cm.



OPERA

# NINIVE



HANGING-LAMP, RULED HAND-BLOWN GLASS TRANSPARENT OR FROSTED WITH 40 CM. LENGHT TASSEL INCLUDED, ALSO AVAILABLE IN WALL VERSION.

Cable 2,00 mt. lenght transparent or coated fabric as per color chart.



OPERA

# TIMUR



HANGING-LAMP, RULED HAND-BLOWN GLASS TRANSPARENT OR FROSTED WITH 40 CM. LENGHT TASSEL INCLUDED, ALSO AVAILABLE IN WALL VERSION.

Cable 2,00 mt. lenght transparent or coated fabric as per color chart.

Light source E14. Glass dimension: Large\_h. 53 - ø 20 cm. | Small\_h. 41 - ø 15





OPERA

# LIU "A"



HANGING-LAMP, HAND-BLOWN GLASS TRANSPARENT OR FROSTED WITH 40 CM. LENGHT TASSEL INCLUDED, ALSO AVAILABLE IN WALL VERSION.

Cable 2,00 mt. lenght transparent or coated fabric as per color chart.



OPERA

# LIU "B"



HANGING-LAMP, HAND-BLOWN GLASS TRANSPARENT OR FROSTED WITH 40 CM. LENGHT TASSEL INCLUDED, ALSO AVAILABLE IN WALL VERSION.

Cable 2,00 mt. lenght transparent or coated fabric as per color chart.



OPERA

## LIU "C"



HANGING-LAMP, HAND-BLOWN GLASS TRANSPARENT OR FROSTED WITH 40 CM. LENGTH TASSEL INCLUDED, ALSO AVAILABLE IN WALL VERSION.

Cable 2,00 mt. lenght transparent or coated fabric as per color chart.

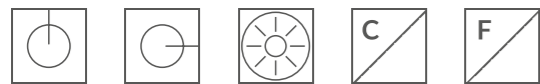

OPERA

## MOON



HANGING-LAMP, HAND-BLOWN GLASS FROSTED ALSO AVAILABLE IN WALL VERSION.

Cable 2,00 mt. lenght transparent or coated fabric as per color chart.

Light source E14. Glass dimension: h. 30 x 5 cm.

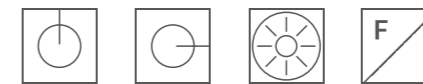

# ACCESSORIES

## ROUND WOODEN CEILING LIGHTS MOUNT

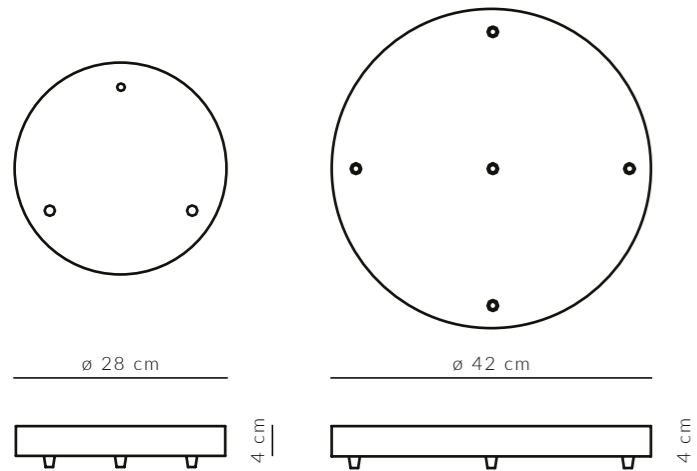

## RECTANGULAR WOODEN CEILING LIGHTS MOUNT

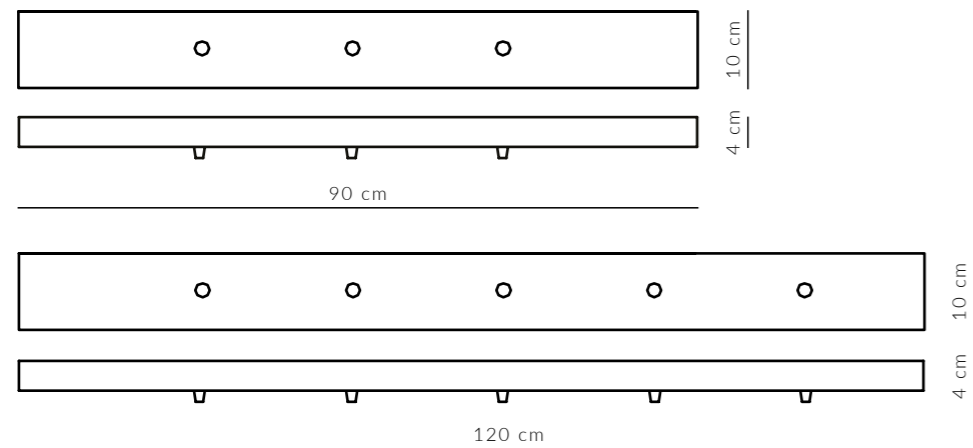

## ROUND WOODEN BRACKET

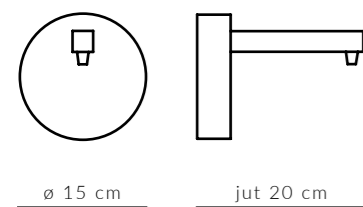

## RECTANGULAR WOODEN BRACKET

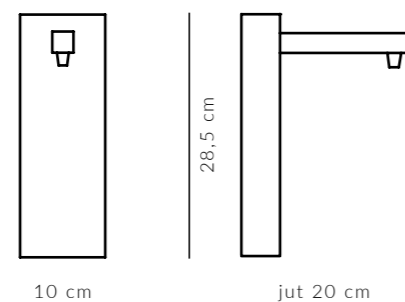

# TASSELS AND CABLES

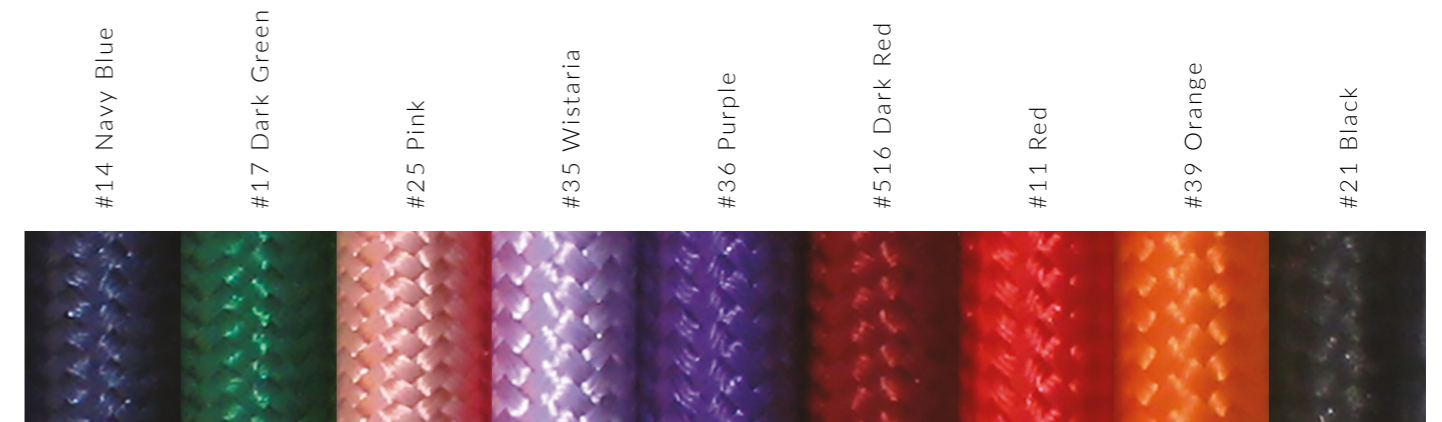
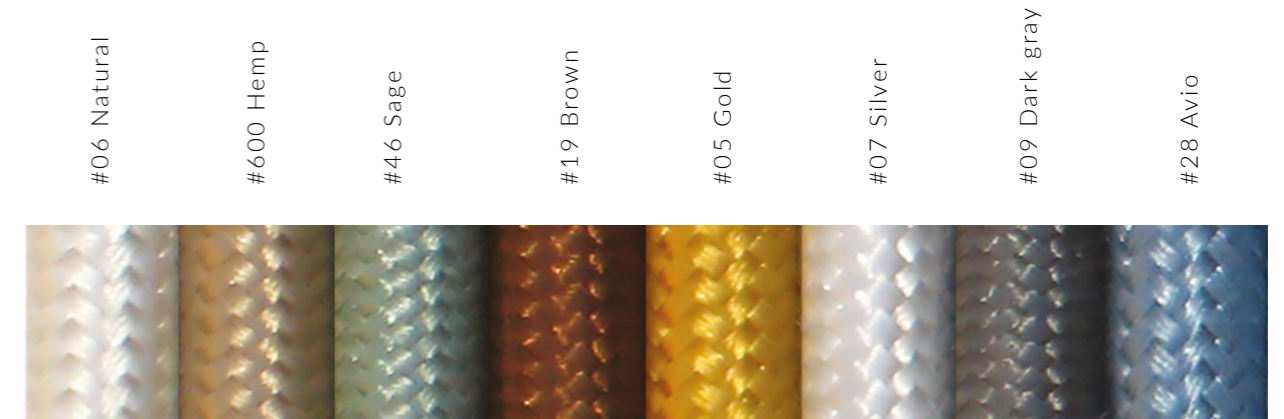

Colors in this catalogue may lightly vary because of printing. melogranoblu reserve the right to modify products and colors, without notice, in order to make technical improvements.

# CREDITS

## COPYRIGHT

© 2024 by melogranoblu srl



## PHOTO

SILVIO SALVADOR

## CATALOGUE DESIGN

BABOL COMMUNICATION  
[www.babolcommunication.com](http://www.babolcommunication.com)

